

Panasonic®

Operating Instructions

DVD Video Recorder

Model No. **DMR-E75V**

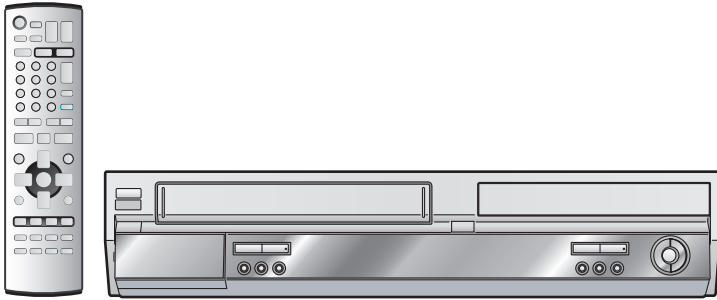

Dear Customer

Thank you for purchasing this product. For optimum performance and safety, please read these instructions carefully.

Before connecting, operating or adjusting this product, please read these instructions completely.
Please keep this manual for future reference.

For U.S.A. only
The warranty can be found on page 71.

For Canada only
The warranty can be found on page 72.

La guía rápida en español se encuentra en la página 75-83.

Before Use

Warning and Important Information

CAUTION!

THIS PRODUCT UTILIZES A LASER.
 USE OF CONTROLS OR ADJUSTMENTS OR PERFORMANCE OF PROCEDURES OTHER THAN THOSE SPECIFIED HEREIN MAY RESULT IN HAZARDOUS RADIATION EXPOSURE. DO NOT OPEN COVERS AND DO NOT REPAIR YOURSELF. REFER SERVICING TO QUALIFIED PERSONNEL.

WARNING:

TO REDUCE THE RISK OF FIRE, ELECTRIC SHOCK OR PRODUCT DAMAGE, DO NOT EXPOSE THIS APPARATUS TO RAIN, MOISTURE, DRIPPING OR SPLASHING AND THAT NO OBJECTS FILLED WITH LIQUIDS, SUCH AS VASES, SHALL BE PLACED ON THE APPARATUS.

CAUTION!

DO NOT INSTALL OR PLACE THIS UNIT IN A BOOKCASE, BUILT-IN CABINET OR IN ANOTHER CONFINED SPACE. ENSURE THE UNIT IS WELL VENTILATED. TO PREVENT RISK OF ELECTRIC SHOCK OR FIRE HAZARD DUE TO OVERHEATING, ENSURE THAT CURTAINS AND ANY OTHER MATERIALS DO NOT OBSTRUCT THE VENTILATION VENTS.

CAUTION:

TO PREVENT ELECTRIC SHOCK MATCH WIDE BLADE OF PLUG TO WIDE SLOT, FULLY INSERT.

THE FOLLOWING APPLIES ONLY IN THE U.S.A. AND CANADA



CAUTION

RISK OF ELECTRIC SHOCK
DO NOT OPEN



CAUTION: TO REDUCE THE RISK OF ELECTRIC SHOCK, DO NOT REMOVE SCREWS. NO USER-SERVICEABLE PARTS INSIDE. REFER SERVICING TO QUALIFIED SERVICE PERSONNEL.



The lightning flash with arrowhead symbol, within an equilateral triangle, is intended to alert the user to the presence of uninsulated "dangerous voltage" within the product's enclosure that may be of sufficient magnitude to constitute a risk of electric shock to persons.



The exclamation point within an equilateral triangle is intended to alert the user to the presence of important operating and maintenance (servicing) instructions in the literature accompanying the appliance.

THE FOLLOWING APPLIES ONLY IN THE U.S.A.

Note to CATV system installer:

This reminder is provided to call the CATV system installer's attention to Article 820-40 of the NEC that provides guidelines for proper grounding and, in particular, specifies that the cable ground shall be connected to the grounding system of the building, as close to the point of cable entry as practical.

THE FOLLOWING APPLIES ONLY IN THE U.S.A.

FCC Note:

This equipment has been tested and found to comply with the limits for a Class B digital device, pursuant to Part 15 of the FCC Rules. These limits are designed to provide reasonable protection against harmful interference in a residential installation. This equipment generates, uses, and can radiate radio frequency energy and, if not installed and used in accordance with the instructions, may cause harmful interference to radio communications. However, there is no guarantee that interference will not occur in a particular installation. If this equipment does cause harmful interference to radio or television reception, which can be determined by turning the equipment off and on, the user is encouraged to try to correct the interference by one or more of the following measures:

- Reorient or relocate the receiving antenna.
- Increase the separation between the equipment and receiver.
- Connect the equipment into an outlet on a circuit different from that to which the receiver is connected.
- Consult the dealer or an experienced radio/TV technician for help.

FCC Caution: To assure continued compliance, follow the attached installation instructions and use only shielded interface cables when connecting to peripheral devices. Any changes or modifications not expressly approved by the party responsible for compliance could void the user's authority to operate this equipment.

This device complies with Part 15 of the FCC Rules. Operation is subject to the following two conditions: (1) This device may not cause harmful interference, and (2) this device must accept any interference received, including interference that may cause undesired operation.

DANGER	• VISIBLE AND INVISIBLE LASER RADIATION WHEN OPEN. AVOID DIRECT EXPOSURE TO BEAM. (FDA 21 CFR)
CAUTION	• VISIBLE AND INVISIBLE LASER RADIATION WHEN OPEN. AVOID EXPOSURE TO BEAM. (IEC60825-1)
ATTENTION	• RAYONNEMENT LASER VISIBLE ET INVISIBLE EN CAS D'OUVERTURE. EXPOSITION DANGEREUSE AU FAISCEAU.
ADVARSEL	• SYNLIG OG USYNLIG LASERSTRÅLING VED ÅBNING. UNDGÅ UDSÆTTELSE FOR STRÅLING.
VARO!	• AVATTAESSA OLET ALTIINA NÄKYVÄÄ JA NÄKYMÄTÖN LASERSÄTEILYLLE. ÄLÄ KATSO SÄTEESEEN.
WARNING	• SYNLIG OCH OSYNLIG LASERSTRÅLNING NÄR DENNA DEL ÄR ÖPPNAD. BETRÄKTA EJ STRÅLEN.
ADVARSEL	• SYNLIG OG USYNLIG LASERSTRÅLING NÄR DEKSEL ÅPNES. UNDGÅ EKSPONERING FOR STRÅLEN.
VORSICHT	• SICHTBARE UND UNSICHTBARE LASERSTRÄHLUNG. WENN ABDECKUNG GEÖFFNET, NICHT DEM STRAHL AUSSETZEN.
注意	• 打开时有可见及不可见激光辐射。避免激光束照射。
注意	• ここを覗くと有害及び不可視のレーザー光が出ます。ビームを直接見たり、触れたりしないでください。 RQLS0233

(Inside of product)

Before Use

IMPORTANT SAFETY INSTRUCTIONS

Read these operating instructions carefully before using the unit. Follow the safety instructions on the unit and the applicable safety instructions listed below. Keep these operating instructions handy for future reference.

- (1) Read these instructions.
- (2) Keep these instructions.
- (3) Heed all warnings.
- (4) Follow all instructions.
- (5) Do not use this apparatus near water.
- (6) Clean only with dry cloth.
- (7) Do not block any ventilation openings. Install in accordance with the manufacturer's instructions.
- (8) Do not install near any heat sources such as radiators, heat registers, stoves, or other apparatus (including amplifiers) that produce heat.
- (9) Do not defeat the safety purpose of the polarized or grounding-type plug. A polarized plug has two blades with one wider than the other. A grounding-type plug has two blades and a third grounding prong. The wide blade or the third prong are provided for your safety. If the provided plug does not fit into your outlet, consult an electrician for replacement of the obsolete outlet.
- (10) Protect the power cord from being walked on or pinched particularly at plugs, convenience receptacles, and the point where they exit from the apparatus.
- (11) Only use attachments/accessories specified by the manufacturer.
- (12) Use only with the cart, stand, tripod, bracket, or table specified by the manufacturer, or sold with the apparatus. When a cart is used, use caution when moving the cart/apparatus combination to avoid injury from tip-over.
- (13) Unplug this apparatus during lightning storms or when unused for long periods of time.
- (14) Refer all servicing to qualified service personnel. Servicing is required when the apparatus has been damaged in any way, such as power-supply cord or plug is damaged, liquid has been spilled or objects have fallen into the apparatus, the apparatus has been exposed to rain or moisture, does not operate normally, or has been dropped.



The manufacturer accepts no responsibility and offers no compensation for loss of recorded or edited material due to a problem with the unit or recordable media, and accepts no responsibility and offers no compensation for any subsequent damage caused by such loss.

Examples of causes of such losses are

- A disc recorded and edited with this unit is played in a DVD recorder or computer disc drive manufactured by another company.
- A disc used as described above and then played again in this unit.
- A disc recorded and edited with a DVD recorder or computer disc drive manufactured by another company is played in this unit.

About descriptions in these Operating Instructions

Pages to be referred to are indicated as (→ ○○).

The explanations concerning discs are indicated by [DVD], those concerning video are indicated by [VHS].

Accessories

Please check and identify the supplied accessories. Use numbers indicated in parentheses when asking for replacement parts.

Only for U.S.A.: To order accessories, refer to “Accessory Purchases” on page 71.

Only for Canada: To order accessories, call the dealer from whom you have made your purchase.



- 1 AC power supply cord**
(K2CB2CB00006)

• For use with this unit only. Do not use it with other equipment.

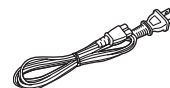

- 1 75 Ω coaxial cable**
(K2KZ2BA00001)

- 1 Audio/Video Cable**
(K2KA6CA00001)



- 2 Batteries for the Remote Control**
R6 size

- 1 Remote Control**
(EUR7721X10)

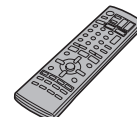

(U.S.A. only)

Product Registration Card

Please complete and return the included product registration card, or register via the Internet at: <http://www.prodreg.com/panasonic/>

Useful features

You can enjoy both VHS and DVD with this unit.

This DVD Video recorder records high quality images to rapid random access capable DVD-RAM media. This has resulted in many new features that outperform older tape formats. The following information summarizes a few of these features.

Instant play (→ 21, 33)

There is no need to rewind or search forward. Direct Navigator guides you to the beginning of the recorded video immediately.

Instant recording (→ 26)

You no longer need to search for empty disc space. By pressing the recording button, the unit finds available recording space and begins recording right away. There is no need to worry about overwriting already recorded content.

Chasing playback (→ 25)

There is no need to wait until recording is complete. Without stopping recording, you can play the video currently being recorded from its beginning.

Simultaneous Recording and Play (→ 25)

While recording, you can play another video program that was recorded previously.

Time Slip (→ 23, 25)

During play and also while recording, you can jump to the scene you wish to view by specifying the skip time.

One touch dubbing (→ 58, 60)

Memorable contents on VHS can be easily dubbed onto DVD. “One touch 2-way Transfer/Dubbing” enables you to copy from VHS to DVD and vice versa.

Before Use

Contents

Before Use	Recording
Warning and Important Information2	Playing while you are recording 25
IMPORTANT SAFETY INSTRUCTIONS.....3	• Chasing play 25
About descriptions in these Operating Instructions3	• Simultaneous recording and play 25
Accessories3	• TIME SLIP 25
Useful features3	Watching the TV while recording..... 25
Contents4	Recording TV programs 26
Control reference guide6	Playing/Recording VHS while recording..... 26
• Remote control6	• Recording modes and approximate recording times 27
• Batteries7	Selecting audio to record..... 27
• Use7	Flexible Recording mode (FR) 27
• Main unit7	
• The unit's display8	Timer Recording
STEP 1 Connection9	Using VCR Plus+ system 28
• Connecting a TV and VCR 10	Manual programming 28
• Connecting a cable TV box/satellite receiver 11	Check, change or delete programs 29
If the antenna connector doesn't match..... 11	Cautions for using timer recording on DVD and VHS 29
• Other antenna connections to the unit 11	
• Other antenna connections from the unit to the TV 11	Advanced Operations
Connecting amplifier or system component..... 12	DISC SETTING 30
• To enjoy multi-channel surround sound on DVD-Video (digital connection)..... 12	- Disc Name 30
• Connection to a stereo amplifier (analog connection) 12	- Disc Protection 30
DVD output and DVD/VHS output 12	- Format disc..... 31
STEP 2 Plug-in Auto Tuning 13	- Select First play 31
• If Plug-in Auto Tuning fails 14	- Finalize 31
• Adding and deleting channels 14	Entering text 32
STEP 3 Channel settings..... 15	Using the Direct Navigator 33
• Guide channel settings for VCR Plus+ system 15	• Selecting recorded titles to play 33
• Channel captions..... 16	• Direct Navigator 33
- Preset Channel Captions 16	- Erase 33
- Manual Channel Captions..... 16	- Properties 33
STEP 4 Set up to match your TV and remote control..... 17	- Edit 34
• Selecting TV type 17	- Chapter View 35
• TV operation 17	Using play list 36
• When other Panasonic products respond to this remote control 17	• Creating play lists..... 36
	• Playing play lists 37
	• Using play list to edit play lists/chapters 37
	- Erase 37
	- Properties 37
	- Edit 38
	- Chapter View 39
	Using DISPLAY menus 40
	• Common procedures 40
	- Disc menu 40
	- Play menu 41
	- Video menu 41
	- Audio menu 41
	Various Settings
	Changing the unit's settings 42
	• Common procedures 42
	Entering a password (Ratings) 42
	Summary of settings..... 43
	Clock Settings 46
	- Auto Clock Setting..... 46
	- Time Zone Adjust 46
	- Manual Clock Setting 46
	FUNCTIONS window 47
	Status displays 47
	• Changing the information displayed..... 47
	• Display examples..... 47
	VHS
	Before Use
	Inserting video cassette..... 48
	Video cassette information 48
	• Video cassettes 48
	• Video cassette care 48
	• Maintenance 48

Before Use

Playback	
Playing a video cassette.....	49
Fast-forward / Rewind.....	49
Cue / Review.....	49
Jet Search.....	49
Slow.....	49
Jet Rewind.....	49
S-VHS Quasi Playback (SQPB).....	50
Repeat Playback.....	50
Adjusting the playback picture.....	50
• Manual tracking.....	50
• Vertical locking adjustment.....	50
Recording	
Recording TV programs.....	51
Watching the TV while recording.....	51
Playing/Recording DVD while recording.....	51
Timer Recording	
Using VCR Plus+ system.....	52
Manual programming.....	52
Auto SP/EP mode.....	53
Check, change or delete programs.....	53
Cautions for using timer recording on DVD and VHS.....	53
Advanced Operations	
Direct Navigator.....	54
• To save Direct Navigator data.....	54
• Selecting programs to play.....	54
• Set the category.....	55
To Check the Recorded Programming Data (Time Stamp Function).....	55
VHS Index Search System (VISS).....	55
Various Settings	
Changing the unit's settings.....	56
• Common procedures.....	56
Summary of settings.....	56
Various on-screen display indications.....	57
Changing audio.....	57
Auto Bilingual Choice Function.....	57
DVD/VHS	
Advanced Operations	
Transfer (Dubbing) from VHS.....	58
• One Touch Transfer (Dubbing) (VHS → DVD).....	58
• Manual Transfer (Dubbing).....	59
Transfer (Dubbing) from DVD.....	60
• One Touch Transfer (Dubbing) (DVD → VHS).....	60
• Manual Transfer (Dubbing).....	61
Recording from an external device.....	62
- DVD.....	62
- VHS.....	62
Helpful Hints	
Glossary.....	63
Frequently asked questions.....	64
Error messages.....	65
• Common.....	65
• DVD.....	65
• VHS.....	65
Troubleshooting guide.....	66
• Common.....	66
• DVD.....	68
• VHS.....	69
Product Service.....	70
• Product information.....	70
Limited Warranty (ONLY FOR U.S.A.).....	71
Limited Warranty (ONLY FOR CANADA).....	72
Specifications.....	73
Index.....	74

Español

Antes de uso

- Conexión a un televisor o a un VCR..... 75

DVD

Sintonización automática por enchufe.....	76
Ajustes del canal de guía para el sistema VCR Plus+.....	76
Selección del tipo de televisor.....	76

Reproducción

Introducción de discos.....	77
Reproducción de los discos.....	77
• Cuando en el televisor aparece la pantalla de un menú.....	77
Vista rápida (Reproducción X1.3).....	77
Continuación de la reproducción (Función Resume).....	77
Avance rápido y rebobinado—SEARCH.....	77
Reproducción de cámara lenta.....	77
Visión cuadro por cuadro.....	78
Salto.....	78
Reproducción directa.....	78
Salto CM.....	78
Visualización de la imagen TV como imagen en imagen/ Selección de la cantidad de tiempo a saltar—Time Slip.....	78
Borrado de un título que se está reproduciendo.....	78
Crear capítulos.....	78

Grabación

Reproducción durante la grabación.....	79
• Reproducción seguida.....	79
• Grabación y reproducción simultáneas.....	79
• TIME SLIP.....	79
Recepción de las transmisiones televisivas durante la grabación.....	79
Grabación de programas televisivos.....	79
• Modos de grabación y tiempo aproximado de grabación.....	79

Ejecución de grabaciones temporizadas

Uso del sistema VCR Plus+.....	80
Programación manual.....	80
Controle, cambie o borre el programa.....	80
Precauciones al usar la grabación temporizada en DVD y VHS.....	80

VHS

Reproducción

Introducción de un cassette de vídeo.....	81
Cassette de vídeo.....	81
Reproducción de un cassette de vídeo.....	81
Avance rápido / Rebobinado.....	81
Localización progresiva / Rebobinado.....	81
Búsqueda Jet.....	81
Lento.....	81
Rebobinado Jet.....	81
Quasi reproducción S-VHS (SQPB).....	81
Reproducción repetida.....	81

Grabación

Grabación de programas televisivos.....	82
Recepción de las transmisiones televisivas durante la grabación.....	82

Ejecución de grabaciones temporizadas

Uso del sistema VCR Plus+.....	83
Programación manual.....	83
Modo SP/EP automático.....	83
Controle, cambie o borre el programa.....	83
Precauciones al usar la grabación temporizada en DVD y VHS.....	83

Before Use

Control reference guide

Remote control

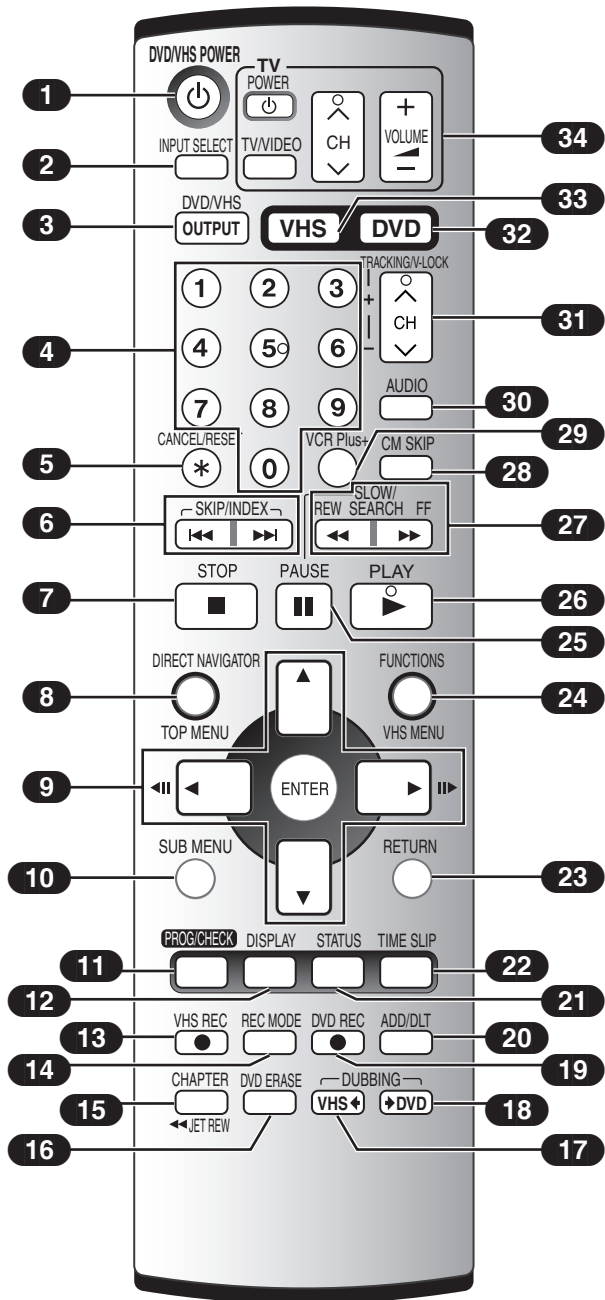

■ [VHS] and [DVD] button

[DVD]

- Switch the remote control mode to DVD. Make sure you press before performing DVD operations. When in DVD mode, the [DVD] button lights each time you press one of the buttons on the remote control.

[VHS]

- Switch the remote control mode to VHS. Make sure you press before performing VHS operations. When in VHS mode, the [VHS] button lights each time you press one of the buttons on the remote control.

- 1 DVD/VHS POWER on/off button (⏻, DVD/VHS POWER)→ 13
- 2 Input select button (INPUT SELECT)→ 62
- 3 DVD/VHS output button (OUTPUT, DVD/VHS)→ 12
- 4 Numeric buttons (0–9)
- 5 Cancel/Reset and asterisk button (CANCEL/RESET, *)
- 6 Skip/Index buttons (◀◀, ▶▶, SKIP/INDEX)
- 7 Stop button (■, STOP)
- 8 Top menu and Direct Navigator button (TOP MENU, DIRECT NAVIGATOR)
- 9 Cursor buttons (▲, ▼, ◀, ▶)/Frame buttons (◀◀, ▶▶)/Enter button (ENTER)
- 10 Sub menu button (SUB MENU)
- 11 Manual programming and check button (PROG/CHECK)
- 12 Display button (DISPLAY)→ 40
- 13 VHS recording button (●, VHS REC)→ 51, 61

When you press this button in the DVD remote control mode, it is automatically switched to the VHS remote control mode.

- 14 Recording mode button (REC MODE).....→ 26, 51
- 15 Chapter button (CHAPTER)/Jet rewind button (◀◀ JET REW).....→ 23, 49
- 16 DVD erase button (DVD ERASE)→ 23
- 17 VHS dubbing button (VHS ↕, DUBBING).....→ 60
- 18 DVD dubbing button (↕ DVD, DUBBING).....→ 58
- 19 DVD recording button (●, DVD REC)→ 26, 59

When you press this button in the VHS remote control mode, it is automatically switched to the DVD remote control mode.

- 20 Add/Delete button (ADD/HLT)→ 14
- 21 Status display button (STATUS)→ 47, 57
- 22 Time slip button (TIME SLIP).....→ 23, 25
- 23 Return button (RETURN)
- 24 Functions (FUNCTIONS)/VHS menu (VHS MENU) button→ 47, 56
- 25 Pause button (⏸, PAUSE)
- 26 Play button (▶, PLAY)
- 27 Slow/Search, rewind, forward buttons (◀◀, ▶▶, SLOW/SEARCH, REW, FF)
- 28 CM skip button (CM SKIP)→ 22
- 29 VCR Plus+ button (VCR Plus+)→ 28, 52
- 30 Audio button (AUDIO).....→ 23, 27, 57
- 31 TRACKING/V-LOCK→ 50/Channel up/down buttons (CH, ▲, ▼)
- 32 DVD select button (DVD)→ above
- 33 VHS select button (VHS)→ above
- 34 TV operation buttons
 - POWER on/off button (POWER, ⏻).....→ 17
 - TV/VIDEO input mode select button (TV/VIDEO).....→ 25, 51
 - Channel up/down buttons (CH, ▲, ▼).....→ 25, 51
 - Volume up/down buttons (VOLUME, +, -)

Before Use

Batteries

- Insert so the poles (+ and -) match those in the remote control.
- Do not use rechargeable type batteries.

Do not:

- mix old and new batteries.
- use different types at the same time.
- heat or expose to flame.
- take apart or short circuit.
- attempt to recharge alkaline or manganese batteries.
- use batteries if the covering has been peeled off.

Mishandling of batteries can cause electrolyte leakage which can damage items the fluid contacts and may cause a fire.

Remove if the remote control is not going to be used for a long period of time. Store in a cool, dark place.

Note

- If you cannot operate the unit or TV using the remote control after changing the batteries, please re-enter the codes (→ 17).

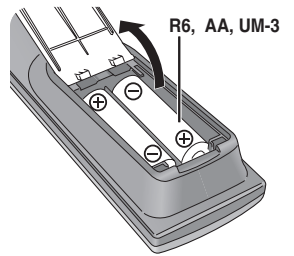

Use

Aim at the sensor, avoiding obstacles, at a maximum range of 7 m (23 feet) directly in front of the unit.

- Keep the transmission window and the unit's sensor free from dust.
- Operation can be affected by strong light sources, such as direct sunlight, and the glass doors on cabinets.

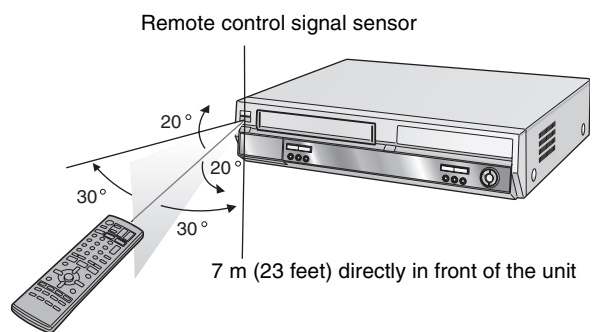

Main unit

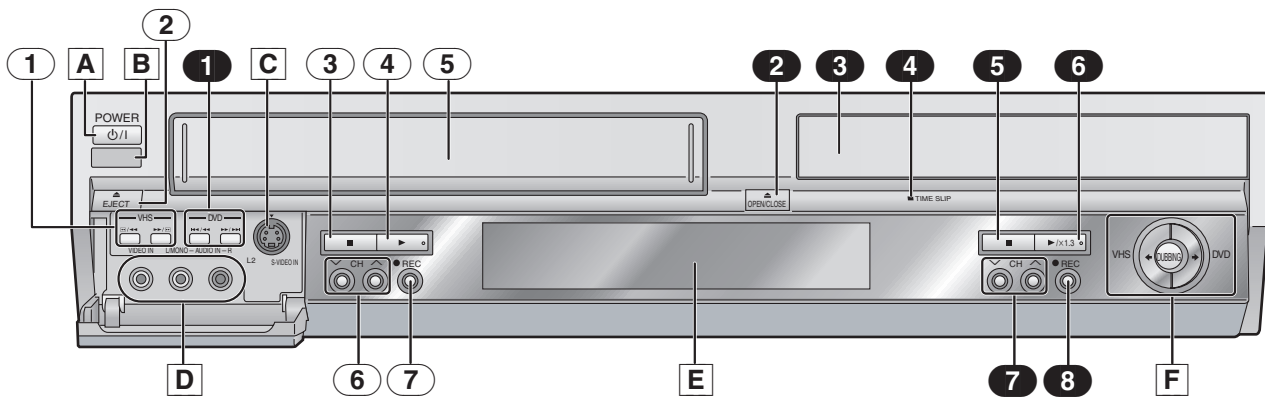

Common to DVD/VHS

- A** DVD/VHS POWER on/off button (⏻/I, POWER) → 13
 - To switch the unit from on to standby mode or vice versa. In the standby mode, the unit is still consuming a small amount of power.
- B** Remote control signal sensor → above
- C** S-Video input terminal (S-VIDEO IN) → 62
- D** L2 input terminals (L2) → 62
- E** Display → 8
- F** One Touch Transfer (Dubbing) operation button
 - From VHS to DVD → 58
 - From DVD to VHS → 60

VHS

- 1** VHS Search buttons (⏮/⏪, ⏩/⏭) → 48
- 2** Cassette eject button (⏏, EJECT) → 48
- 3** VHS Stop button (■) → 49
- 4** VHS Play button (▶) → 49
- 5** Cassette compartment
- 6** VHS Channel up/down buttons (CH, ▲, ▼) → 50
- 7** VHS Recording button (●, REC) → 51

DVD

- 1** DVD Skip/Slow/Search buttons (⏮/⏪, ⏩/⏭) → 20
- 2** Disc tray open/close button (⏏, OPEN/CLOSE) → 20
- 3** Disc tray → 20
- 4** Time slip indicator (TIME SLIP) → 25
 - While both recording and play are activated, this indicator lights up.
- 5** DVD Stop button (■)
- 6** DVD Play/×1.3 button (▶/×1.3) → 21
- 7** DVD Channel up/down buttons (CH, ▲, ▼)
- 8** DVD Recording button (●, REC) → 26

Off Timer

The unit switches to standby when it is not being used about 6 hours.

You can turn this feature off or change the time to 2 hours. (→ 43, "Off Timer")

Before Use

■ The unit's display

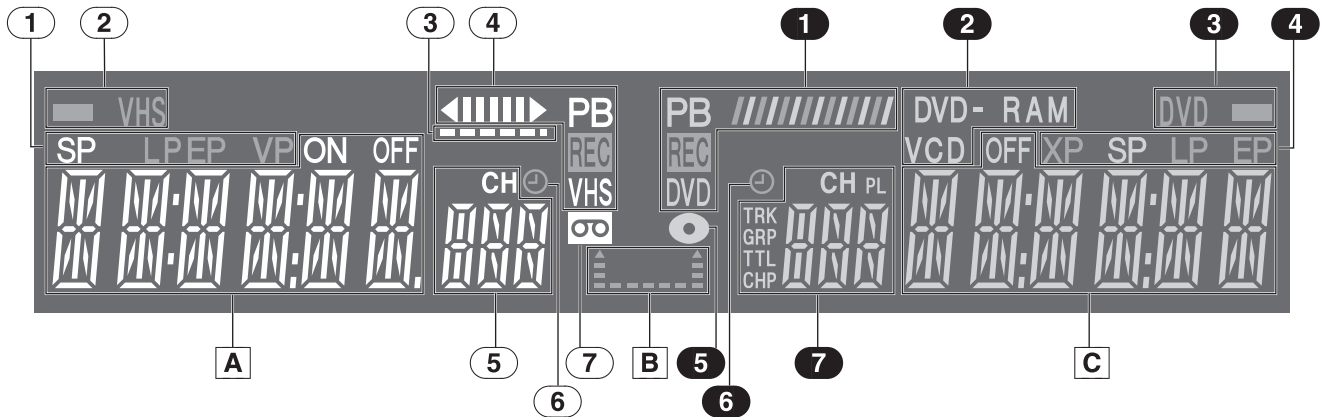

Common to DVD/VHS

A Main display

- Current time
- VHS recording and play counter
- Timer recording start time
- Miscellaneous messages, etc.

B Transfer (Dubbing) direction indicator

C Main display

- Disc play counter
- Timer recording end time
- Miscellaneous messages, etc.

VHS

① Tape speed indicator (→ 51)

- SP: When recording or playing in Normal mode.
- LP: When playing in Long play mode.
- EP: When recording or playing in Extra long play mode.
- VP: When recording or playing in five-time (Long play) mode.

② VHS output indicator

③ Remaining tape time indicator

④ Tape operation status

- The operation status of this unit, such as playback, fast forward, etc.

⑤ Channel

⑥ Timer program display (⊖) (→ 52)

On:

When a timer program is registered and recordable tape is inserted.

Flashes:

When the unit cannot record the registered program (e.g. there is no tape, etc.) from 2 minutes before starting a timer program to the end of the timer program.

⑦ Tape indicator

DVD

① Disc operation status

② Disc type

③ DVD output indicator

④ Recording mode (→ 27)

- XP SP LP EP (all on): FR mode (→ 27)

⑤ Disc indicator

⑥ Timer program display (⊖) (→ 28)

On:

When a timer program is registered and recordable disc is inserted.

Flashes:

When the unit cannot record the registered program (e.g. there is no disc, etc.) from 2 minutes before starting a timer program to the end of the timer program.

⑦ Channel position indicator

- TRK: track number
- GRP: group number
- TTL: title number
- CHP: chapter number
- CH: channel
- PL: play list number

Note

- A half mirror is used for the unit's display so the display may occasionally be difficult to see depending on surrounding conditions.

Before Use

STEP 1 Connection

Examples of equipment you can connect to this unit's terminals

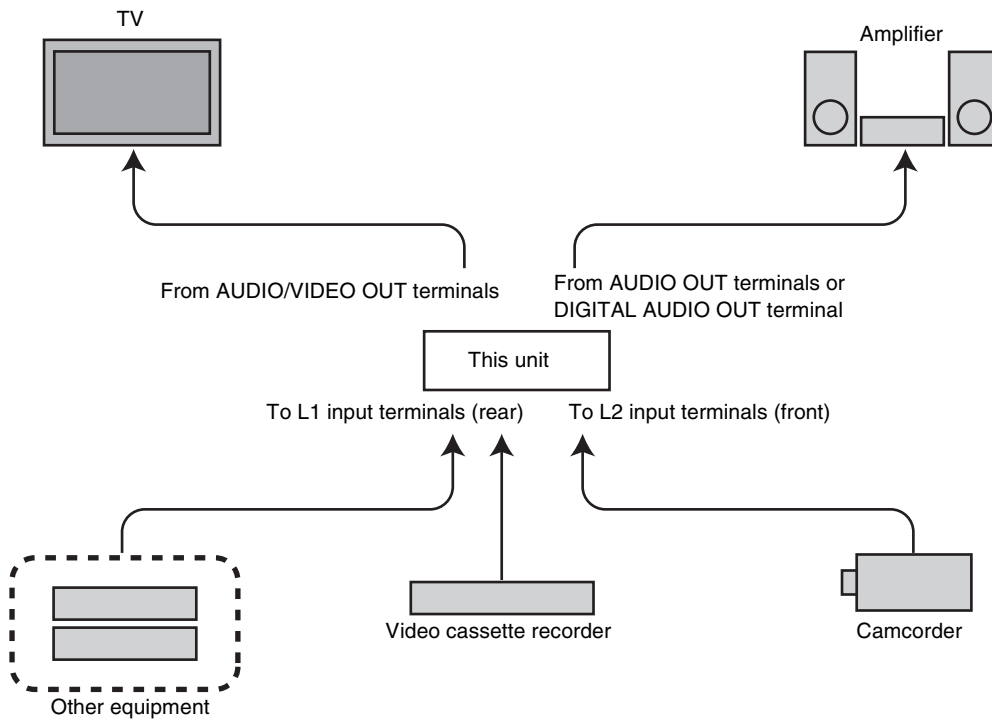

Do not place the unit on amplifiers or equipment that may become hot.
The heat can damage the unit.

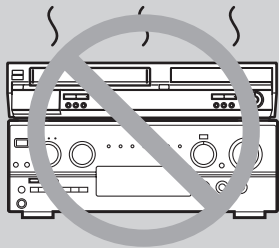

Before moving the unit, ensure the disc tray is empty.
Failure to do so will risk severely damaging the disc and the unit.

When the unit is not to be used for a long time

To save power, unplug it from the household AC outlet. This unit consumes a small amount of power even when it is turned off (approx. 2 W).

Do not connect the unit through a video cassette recorder

Video signals fed through video cassette recorders will be affected by copyright protection systems and the picture will not be shown correctly on the TV.

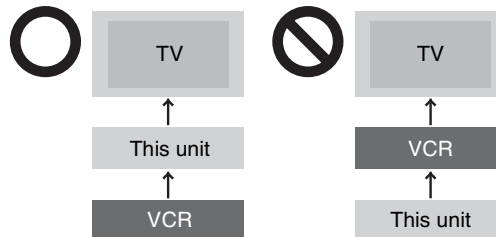

• When connecting to a TV with a built in VCR, connect to the input terminals on the TV side, not the VCR side.

Before Use

- The equipment connections described are examples.
- Before connection, turn off all equipment and read the appropriate operating instructions.
- Peripheral equipment and optional cables sold separately unless otherwise indicated.

■ Connecting a TV and VCR

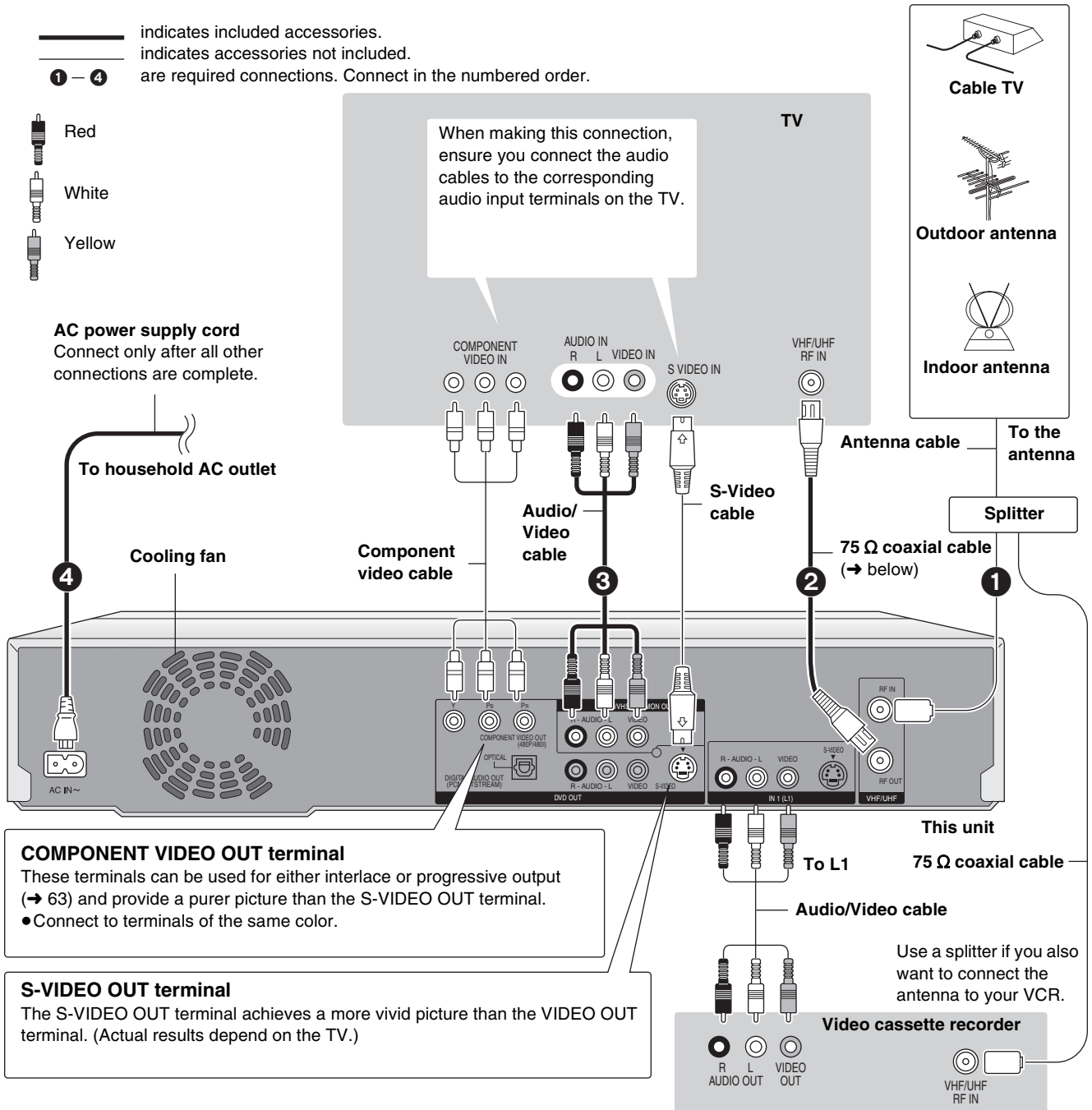

■ 75 Ω coaxial cable

- The picture and sound signal from this unit does not go through the 75 Ω coaxial cable to the TV. Make sure you connect one of the following terminals on this unit to the TV: the AUDIO/VIDEO OUT terminal, the S-VIDEO OUT terminal or the COMPONENT VIDEO OUT terminal. If the TV has none of these terminals, consult your local dealer.
- Refer to page 11 to if the antenna connector doesn't match.

Before Use

■ Connecting a cable TV box/satellite receiver

- You need to subscribe to a cable TV or satellite TV service to enjoy viewing their programming.
- Consult your service provider regarding appropriate cable TV box or satellite receiver.

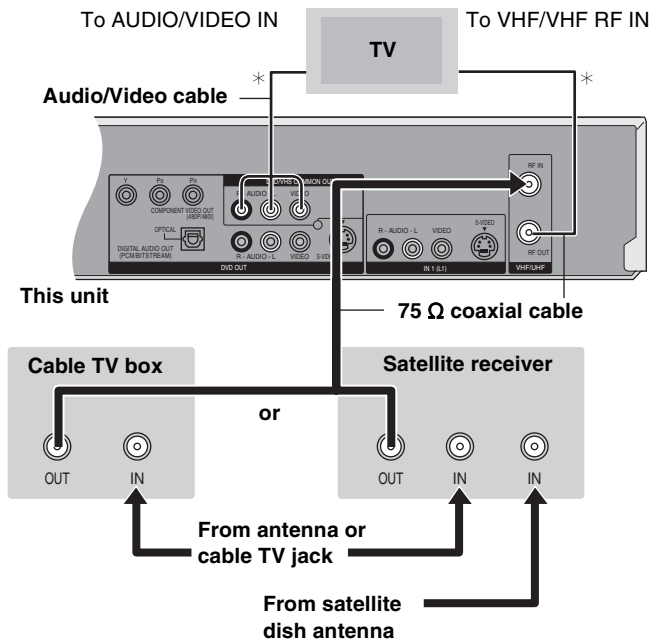

- You can record and view simultaneously scrambled and unscrambled channels if connections are made as shown in the diagram below.

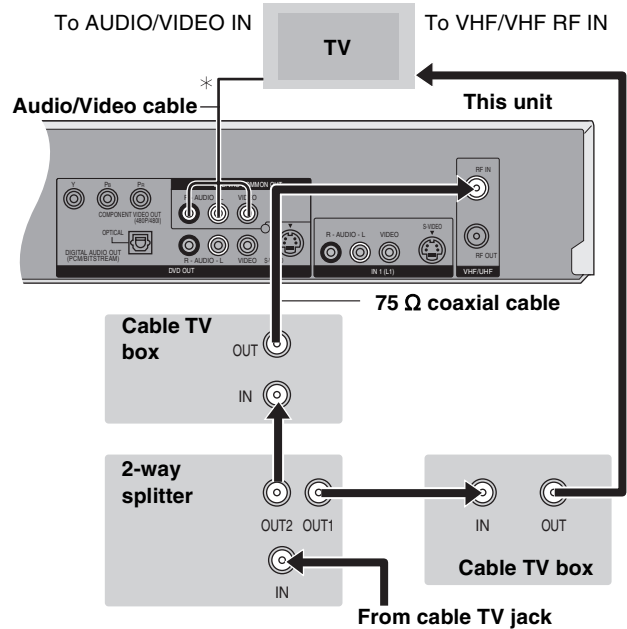

* For more information on connections (→ 10)

If the antenna connector doesn't match

■ Other antenna connections to the unit

Use one of the following connections to suit the antenna lead.

- If your TV has both lead and coaxial VHF terminals, use the lead connection to minimize signal loss.

■ A single twin lead

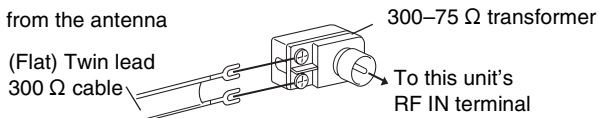

■ A twin lead and a coaxial cable

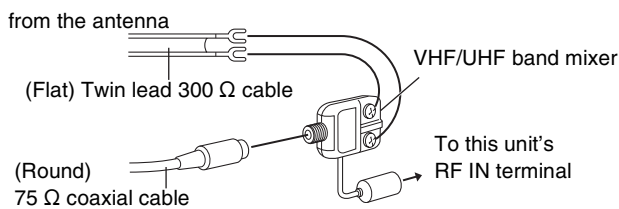

■ Two twin leads

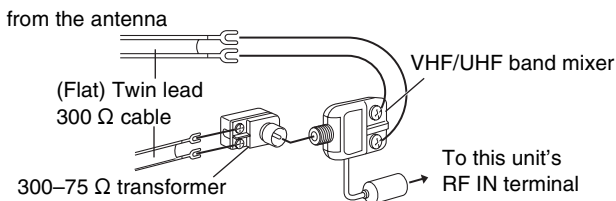

■ Other antenna connections from the unit to the TV

Use one of the following connections to suit the antenna terminals on your TV. Refer to the TV's operating instructions.

■ A twin lead and coaxial plug terminal

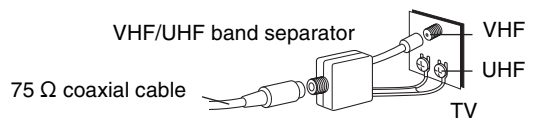

■ A twin lead terminal

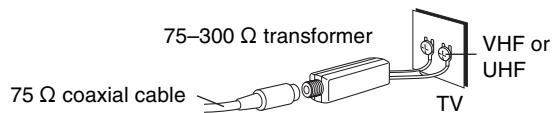

■ Two twin lead terminals

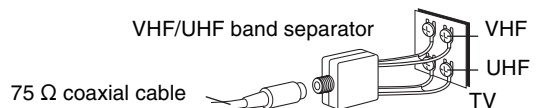

■ Multiple antenna terminals

- Connect to one of the ANT terminals, then change the TV's setting as necessary.

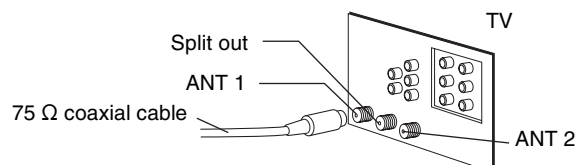

Before Use

Connecting amplifier or system component

To enjoy multi-channel surround sound on DVD-Video (digital connection)

Connect an amplifier with a built-in decoder with these logo marks.



- Use an optical digital audio cable.
- Change the settings in "Digital Audio Output" (→ 44).
- You cannot use DTS Digital Surround decoders not suited to DVD.
- Even if using this connection, output will be only 2 channels when playing DVD-Audio

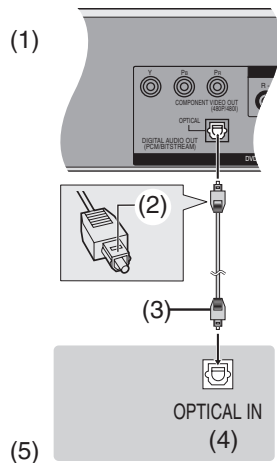

DOLBY DIGITAL **Dolby Digital (→ 44)**
 This is a method of coding digital signals developed by Dolby Laboratories. Not only stereo (2 channel) audio, these signals can also be 5.1-channel audio. A large amount of audio information can be recorded on one disc by this method.

DTS SURROUND **DTS Digital Surround (→ 44)**
 This surround system is used in many movie theatres around the world. The separation between channels is good and the compression ratio is low, so realistic sound effects are possible. DTS sound tracks are produced with the assumption that all channels will be used.

Connection to a stereo amplifier (analog connection)

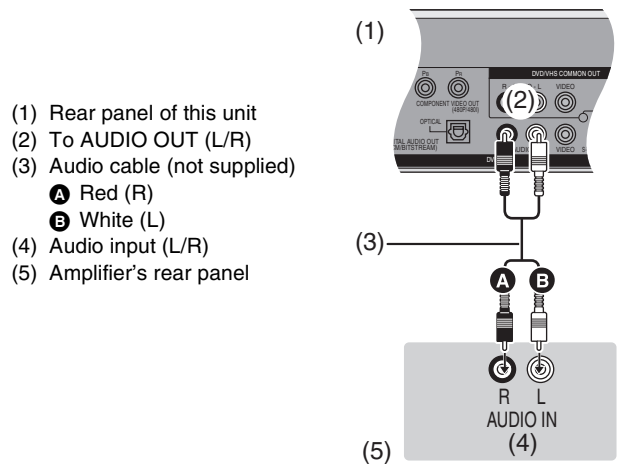

DVD output and DVD/VHS output

This unit has DVD/VHS COMMON output terminals which are common to both DVD and VHS, and DVD output terminals which are exclusively used for DVD.

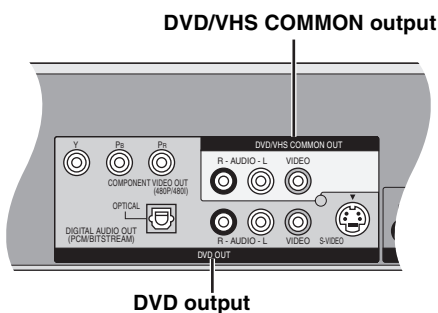

- For DVD/VHS COMMON output terminals, both DVD and VHS outputs can be switched.
- The DVD output terminals can only output the DVD signal.

• Even if "Automatic" is selected in "DVD/VHS Output" on "Set Up" Menu (→ 43), the desired output may not be selected depending on the operation. In this case, press [DVD/VHS OUTPUT] on the remote controller to switch manually.

• When the Video is switched from DVD to VHS or vice versa, the audio volume may suddenly increase or decrease. This is because when the audio output of this unit is connected to the TV or other, the audio output of the DVD is generally lower. When you increase the volume level of the TV or the amplifier to play back DVD audio, reduce it when playback is finished.

Preparation

- Press [DVD].
- 1 While stopped Press [FUNCTIONS]. (→ 47)
- 2 Select "SETUP" with [▲, ▼, ◀, ▶] and press [ENTER].
- 3 Select "Set Up" with [▲, ▼] and press [◀, ▶].
- 4 Select "DVD/VHS Output" with [▲, ▼] and press [ENTER].
- 5 Select "Automatic" or "Manual" with [▲, ▼] and press [ENTER].

Before Use

STEP 2 Plug-in Auto Tuning

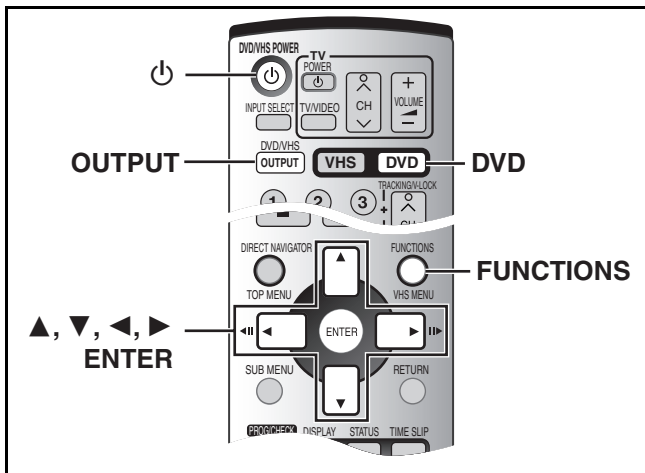

After plugging the unit into your household AC outlet and pressing [⏻, DVD/VHS POWER] to turn the unit on for the first time, the unit assists you to set the on-screen language, and automatically tunes in all the channels it can receive and sets the clock.

The unit automatically determines the type of transmission (airwaves or cable) and puts them into channels as follows.

	Band	Channel
TV Mode (Airwaves)	VHF	2–13
	UHF	14–69
CATV Mode (Cable)	VHF	2–13
	CATV LOW BAND	95–99
	CATV MID/SUPER BAND	14–36
	CATV HYPER BAND	37–65
	ULTRA BAND	66–94 100–125
	SPECIAL CATV CHANNEL	1

Preparation

- Turn on the TV and select the appropriate video input to suit the connections to this unit.
- If you connect the unit through a cable TV box or satellite receiver (→ 11), tune to your local PBS for “Auto Clock Setting” to work. If there is no local PBS, set the clock manually (→ 46, “Manual Clock Setting”).
- Press [DVD].

1 Press [⏻, DVD/VHS POWER].

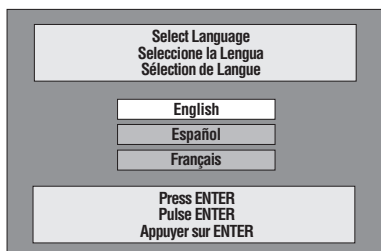

2 Use [▲, ▼] to select the language and press [ENTER].

3 Press [ENTER] to start Plug-in Auto Tuning.

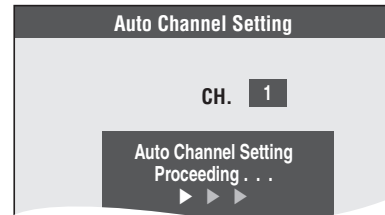

The unit then proceeds with Auto Clock Setting. The time is displayed when finished.

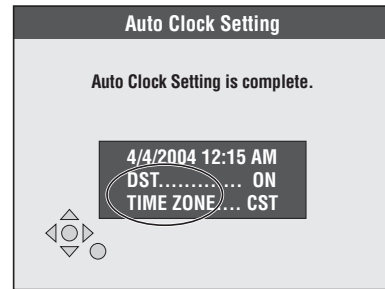

- DST, Daylight Saving Time, shows the summertime setting.
- TIME ZONE shows the time difference from Greenwich mean time (GMT).

EST (Eastern Standard Time) = GMT –5

CST (Central Standard Time) = GMT –6

MST (Mountain Standard Time) = GMT –7

PST (Pacific Standard Time) = GMT –8

AST (Alaska Standard Time) = GMT –9

HST (Hawaii Standard Time) = GMT –10

For other areas: xx hr

4 Press [ENTER].

■ If the clock is an hour slower or faster than the actual time

Select “–1” or “+1” in “Time Zone Adjust” in the SETUP menu (→ 46).

■ If the unit couldn't set the clock automatically

Set the time manually (→ 46, “Manual Clock Setting”).

■ To start Plug-in Auto Tuning again (after relocation, for example)

Antenna system, channel caption, and guide channel settings for VCR Plus+ system all revert to the default values when you perform the procedure below. Timer recording settings are also cleared.

When the unit is on and stopped

1 Press and hold [CH, ▲] and [CH, ▼] on DVD of the main unit for about 5 seconds.

The unit turns off.

2 Press [⏻, DVD/VHS POWER] to turn the unit on.

Before Use

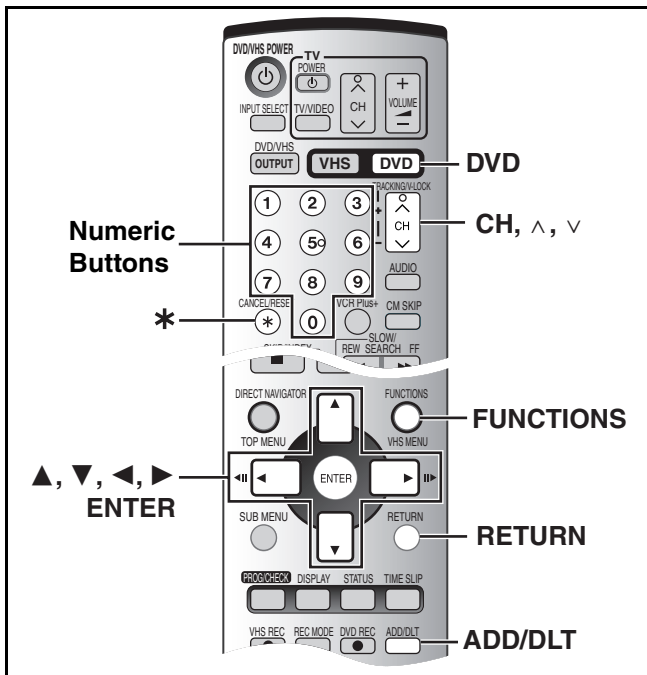

■ Adding and deleting channels

Add or delete channels if necessary channels are not set or unnecessary channels are set.

1 Press the numeric buttons to select a channel.

TV Mode (Airwaves)

e.g., "5": [0]→[5]
 "15": [1]→[5]

CATV Mode (Cable)

e.g., "5": [0]→[0]→[5]
 "15": [0]→[1]→[5]
 "115": [1]→[1]→[5]

Unit's display



• You can also use [CH, ^, v] when you are going to delete a channel.

2 Press [ADD/DLT].

e.g., the channel is deleted.

CHANNEL 15 DELETED

Preparation

- Press [DVD].

■ If Plug-in Auto Tuning fails

- 1 While stopped Press [FUNCTIONS]. (→ 47)
- 2 Select "SETUP" with [▲, ▼, ◀, ▶] and press [ENTER].

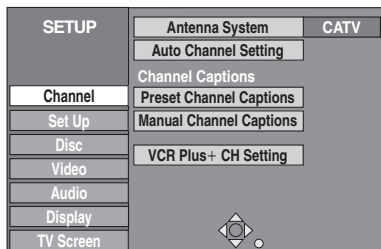

- 3 Select "Channel" with [▲, ▼] and press [◀, ▶].
- 4 Select "Antenna System" with [▲, ▼] and press [ENTER].

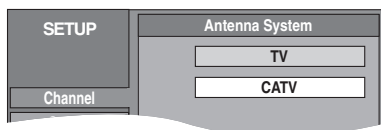

- 5 Select "TV" or "CATV" with [▲, ▼] and press [ENTER].
- 6 Select "Auto Channel Setting" with [▲, ▼] and press [ENTER].
- 7 Press [ENTER].
Auto Channel Setting starts. This takes a few minutes.
- 8 Press [ENTER].

■ To cancel partway

Press [RETURN].

■ When you are finished

Press [RETURN].

Before Use

STEP 3 Channel settings

■ Guide channel settings for VCR Plus+ system

Set these guide channels so you can use VCR Plus+ system for timer recording. Before starting the settings, prepare a chart showing the channels, station names, and guide channels.

e.g.,

Station name	Guide channel*	Channel number**	Channel setting
CBS	04	04	Unnecessary
HBO	33	15	Enter channel 15 next to Guide Channel 33.
Nickelodeon	38	20	Enter channel 20 next to Guide Channel 38.

* Look up the guide channels for the stations in magazines.

** Write down all the stations you can receive.

- If you have connected a cable TV box or satellite receiver, the VCR Plus+ system does not work so you do not have to set the guide channels.

Preparation

- Press [DVD].

1 While stopped

Press [FUNCTIONS]. (→ 47)

2 Select "SETUP" with [▲, ▼, ◀, ▶] and press [ENTER].

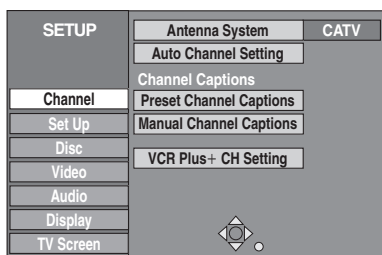

3 Select "Channel" with [▲, ▼] and press [◀, ▶].

4 Select "VCR Plus+ CH Setting" with [▲, ▼] and press [ENTER].

e.g., "Antenna System" is set to "CATV".

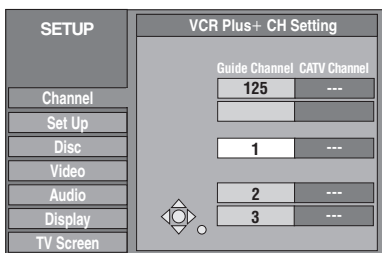

5 Use [▲, ▼] to select the guide channel you want to set and press [▶].

- When selecting the guide channel, press and hold [▲, ▼] to scroll up and down the screen.

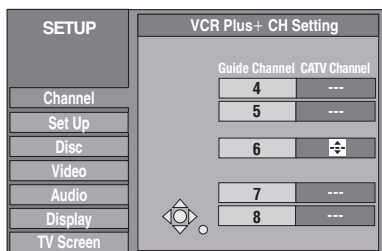

6 Use [▲, ▼] to select the channel corresponding to the guide channel and press [◀].

- To delete a number, press [CANCEL/RESET, *].
- Repeat steps 5 and 6 to enter other channels.

7 Press [ENTER].

■ To return to the previous screen

Press [RETURN].

■ When you are finished

Press [RETURN].

Before Use

Channel captions

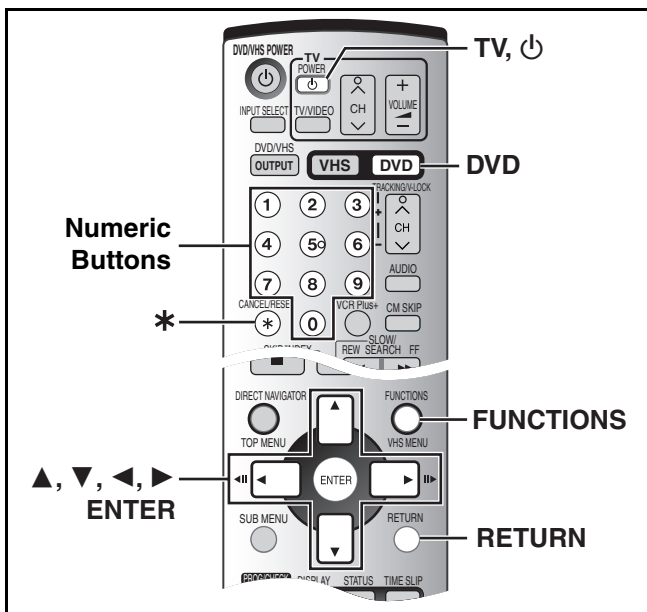

You can use the preset captions, or manually enter new ones yourself.

The captions you enter are displayed when the channel is displayed and in the Direct Navigator screen.

Preparation

- Press [DVD].

- 1 While stopped**
Press [FUNCTIONS]. (→ 47)
- 2 Select "SETUP" with [▲, ▼, ◀, ▶] and press [ENTER].**

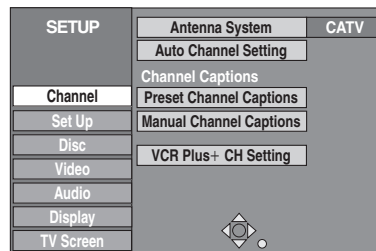

- 3 Select "Channel" with [▲, ▼] and press [◀, ▶].**

▶ Preset Channel Captions

- 4 Select "Preset Channel Captions" with [▲, ▼] and press [ENTER].**

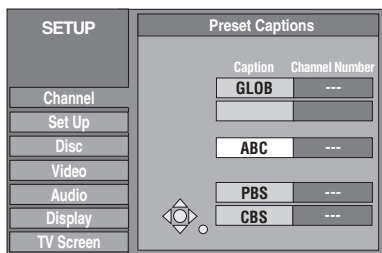

- 5 Use [▲, ▼] to select the caption and press [▶].**

You can choose from the following captions.

ABC, PBS, CBS, CNN, FOX, ESPN, NBC, HBO, A&E, AMC, FAM, MAX, MTV, SHOW, TBS, USA, TNT, CBC, UPN, CTV, WB, TSN, DSC, GLOB

- When selecting the caption, press and hold [▲, ▼] to scroll up and down the screen.

- 6 Use [▲, ▼] to select the channel corresponding to the caption and press [◀].**

- Channels are only displayed if they contain a station and if captions have not been added manually.
- To delete the channel number, press [CANCEL/RESET, *].
- Repeat steps 5 and 6 as necessary.

- 7 Press [ENTER].**

▶ Manual Channel Captions

- 4 Select "Manual Channel Captions" with [▲, ▼] and press [ENTER].**
- 5 Use [▲, ▼] to select the channel and press [▶].**
 - Channels are only displayed if they contain a station and if preset captions have not been added.
- 6 Use [▲, ▼] to select the first character and press [▶].**
 - You can choose from the following characters: A-Z, 0-9, -, &, !, /, (space)
 - To delete the caption, press [CANCEL/RESET, *].
 - Repeat this step to enter the other characters.

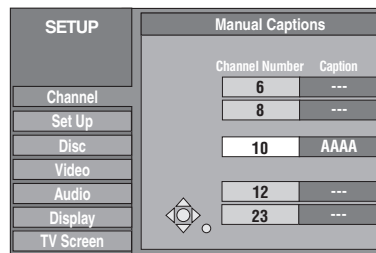

- 7 Use [◀, ▶] to return to the "Channel Number" column.**

- Repeat steps 5-7 to enter other channels.

- 8 Press [ENTER].**

■ To return to the previous screen

Press [RETURN].

■ When you are finished

Press [RETURN].

Before Use

STEP 4 Set up to match your TV and remote control

■ Selecting TV type

You do not have to change the setting when connected to a 4:3 standard aspect TV that is not compatible with progressive output. (→ 63)

Preparation

- Press [DVD].

- 1 While stopped
Press [FUNCTIONS]. (→ 47)
- 2 Select "SETUP" with [▲, ▼, ◀, ▶] and press [ENTER].
- 3 Select "TV Screen" with [▲, ▼] and press [◀, ▶].
- 4 Select "TV Type" with [▲, ▼] and press [ENTER].

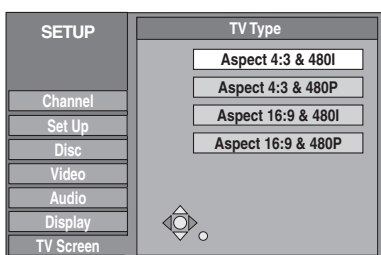

- Aspect 4:3/Aspect 16:9:

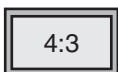

4:3 standard aspect TV

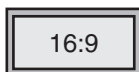

16:9 widescreen TV

- 480P/480I:

Select "480P" if the TV is compatible with progressive output.

- 5 Use [▲, ▼] to select the item and press [ENTER].

■ TV operation

You can configure the remote control TV operation buttons to turn the TV on/off, change the TV input mode, select the TV channel and change the TV volume.

Point the remote control at the TV

While pressing [POWER TV], enter the code using the numeric buttons.

e.g., 01: press [0] → [1].

Manufacturer and Code No.

Panasonic	01, 02	PHILIPS (RC-5)	03
National		RCA	05
QUASAR		SAMSUNG	14, 18, 19
FISHER	10	SANYO	10
GE	05	SHARP	06, 07
GOLDSTAR	15, 16, 17	SONY	08
HITACHI	12	SYLVANIA	03
JVC	11	THOMSON	05
LG	15, 16, 17	TOSHIBA	09
MAGNAVOX	03	ZENITH	04
MITSUBISHI	13		

Test by turning on the TV and changing channels. Repeat the procedure until you find the code that allows correct operation.

- If your TV brand is not listed or if the code listed for your TV does not allow control of your TV, this remote control is not compatible with your TV.

■ When other Panasonic products respond to this remote control

Change the remote control code on the main unit and on the remote control (the two must match) if you place other Panasonic products close together.

Use "1", the factory set code, under normal circumstances.

Preparation

- Press [DVD].

- 1 While stopped
Press [FUNCTIONS]. (→ 47)
- 2 Select "SETUP" with [▲, ▼, ◀, ▶] and press [ENTER].
- 3 Select "Set Up" with [▲, ▼] and press [◀, ▶].
- 4 Select "Remote Control Code" with [▲, ▼] and press [ENTER].
- 5 Use [▲, ▼] to select the code (1, 2, or 3) and press [ENTER].
The code on the unit has been set.
- 6 While pressing [ENTER], press and hold for about 2 seconds the numeric button ([1], [2] or [3]) corresponding to the code you selected in step 5.
The code on the remote control has been set.
- 7 Press [ENTER].

■ When the following indicator appears on the unit's display



The unit's remote control code

Change the code on the remote control to match the main unit's (→ step 6).

■ To return to the previous screen

Press [RETURN].

■ When you are finished

Press [RETURN].

Discs

Discs you can use

● On DVD-Audio, DVD-Video and Video CD, the producer of the material can control how these discs are played. This means that you may not be able to control play of a disc with some operations described in these operating instructions. Read the disc's information for details. The features you can use with the different types of disc are as follows.

Disc type	Logo	Indication in these instructions	Possible operations*					Features
			A	B	C	D	E	
DVD-RAM 4.7 GB / 9.4 GB, 12 cm (5") 2.8 GB 8 cm (3")		RAM	○	○	○	○	○	This disc is able to be rewritten and edited. There are 2 types of DVD-RAM, single-sided and double-sided. The capacity of the double-sided disc is 9.4 GB. (→ below)
DVD-R 4.7 GB 12 cm (5"), 1.4 GB 8 cm (3") for General Ver.2.0 4.7 GB 12 cm (5") for General Ver.2.0/4x-SPEED DVD-R Revision 1.0		DVD-R Not finalized	○	○	○**	×	×	This is a recordable disc with high compatibility and storage stability. (You cannot rewrite it.) This unit is capable of recording DVD-R from 1× speed to 4× speed. (→ below)
		DVD-V Finalized	×	○	×	×	×	
DVD-Audio (Play is in stereo only.)		DVD-A	×	○	×	×	○	This is a disc for music with high sound quality. ● In this unit, it is played with 2 channels (stereo).
DVD-Video		DVD-V	×	○	×	×	○	This is marketed software with high picture quality which already includes movies or music. ● This unit can play discs with symbols (region number) shown on the right.
Video CD		VCD	×	○	×	×	○	This is marketed software which already includes music or video.
Audio CD (Including discs recorded with MP3.)		CD	×	○	×	×	×	This is marketed software which already includes music or audio. This can be a CD-R or a CD-RW including music recorded in MP3 compression technology. ● This unit can play finalized CD-R/CD-RW (audio recording disc) recorded in CD-DA (digital audio), Video CD or MP3 format. Some CD-R or CD-RW may not be played due to the condition of the recording.
	—	MP3	×	○	×	×	×	

* Possible operations (○: enable ×: disable)

A Recording **B** Playback **C** Title erase/Entering text **D** Creating play lists **E** Selecting audio

** The remaining capacity of the disc will not be increased even if erased.

Visit Panasonic's homepage for more information about DVDs. <http://www.panasonic.com/playDVD-R>

More about DVD-RAM and DVD-R

DVD-RAM

- This unit is compatible with the Content Protection for Recordable Media (CPRM) system so you can record broadcasts that allow one copy, such as some CATV broadcasts, onto 4.7 GB/9.4 GB DVD-RAM (these are CPRM compatible). It is not possible to record onto DVD-R or 2.8 GB DVD-RAM.
- DVD-RAMs recorded on this unit cannot be played on incompatible players.
- We recommend using Panasonic's DVD-RAM, which has confirmed compatibility with this unit.
- The aspect ratio of the recorded images will be the same as that of the originals.

Protection of cartridge disc

You can protect the contents of your discs.

- With the write-protect tab in the protect position, you cannot record to, edit, or erase from the disc.

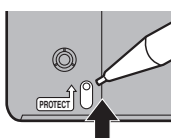

DVD-R

- You can play DVD-R on compatible DVD players by finalizing it on this unit.
- The aspect ratio of the recorded images will be 4:3.
- DVD-R can be recorded only in either of these audio types (Main or SAP). Select the desired audio type in "Select MTS" (→ 44).
- Some broadcasts carry signals that allow you to copy once, but you cannot record them with DVD-R. Use DVD-RAM to record these kinds of broadcast.
- Before finalizing, erasing titles will not increase the disc's available time.
- After finalizing, these DVD-R can no longer be recorded on or edited.
- This unit may not be able to play back DVD-Rs other than Panasonic's product depending on the recording condition. We recommend using Panasonic's DVD-R, which has confirmed compatibility with this unit.
- DVD-R recorded by this unit cannot be reproduced by other Panasonic DVD recorders in some cases.

Discs that cannot be played

- 2.6 and 5.2 GB DVD-RAM, 12 cm (5")
- 3.95 and 4.7 GB DVD-R for Authoring
- Unfinalized DVD-R recorded on other equipment
- PAL discs (you can still play the audio on DVD-Audio)
- DVD-Video with a region number other than "1" or "ALL", DVD-ROM, DVD-RW, +R, +RW, CD-ROM, CDV, CD-G, Photo CD, CVD, SVCD, SACD, MV-Disc, PD, Divx Video Disc, etc.

Maintenance

The precision parts in this unit are readily affected by the environment, especially temperature, humidity, and dust.

Cigarette smoke also can cause malfunction or breakdown.

To clean this unit, wipe with a soft, dry cloth.

- Never use alcohol, paint thinner or benzene to clean this unit.
- Before using chemically treated cloth, read the instructions for the cloth carefully.

Observe the following points to ensure continued listening and viewing pleasure.

Dust and dirt may adhere to the unit's lenses over time, possibly making it impossible to record or play discs.

Use the recommended **DVD-RAM/PD Lens cleaner (LF-K123LCA1)** about once every year, depending on frequency of use and the operating environment.

Read the lens cleaner's instructions carefully before use.

Disc handling

How to hold a disc

Do not touch the recorded surface.

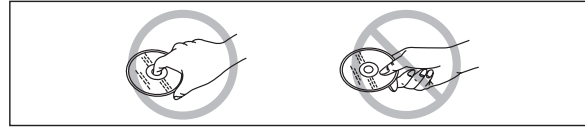

If there is dirt or condensation on the disc

RAM DVD-R

- Clean with an optional DVD-RAM/PD Disc cleaner (**LF-K200DCA1**, where available).
- Do not use cleaners for CDs or cloths.

DVD-A DVD-V VCD CD

Wipe with a damp cloth and then wipe dry.

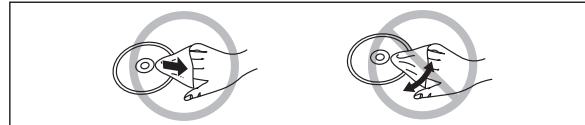

Handling precautions

- Do not attach labels or stickers to discs. (This may cause disc warping and un-balanced rotation, rendering it unusable.)
- Do not write on the label side with a ball-point pen or other writing instrument.
- Do not use record cleaning sprays, benzene, thinner, static electricity prevention liquids or any other solvent.
- Do not use scratch-proof protectors or covers.
- Do not use the following discs:
 - Disc with exposed adhesive from removed stickers or labels (rented discs, etc.).
 - Discs that are badly warped or cracked.
 - Irregularly shaped discs, such as heart shapes.



- Do not place in the following areas:
 - In direct sunlight.
 - In very dusty or humid areas.
 - Near a heater.

Inserting discs

- 1 Press [**▲**, OPEN/CLOSE] on the main unit to open the tray.

You can insert a cartridge or non-cartridge disc.

- 2 Press [**▲**, OPEN/CLOSE] on the main unit to close the tray.

- If you insert a DVD-RAM with the write-protect tab set to "PROTECT" (→ 18), play starts automatically.

Note

- Load double-sided discs so the label for the side you want to record/play is facing up.
- It is not possible to record continuously from one side of a double sided disc to the other. You will need to eject the disc and turn it over.
- When using 8 cm (3") DVD-RAM, remove the disc from the cartridge and insert it, making sure you align it with the groove.

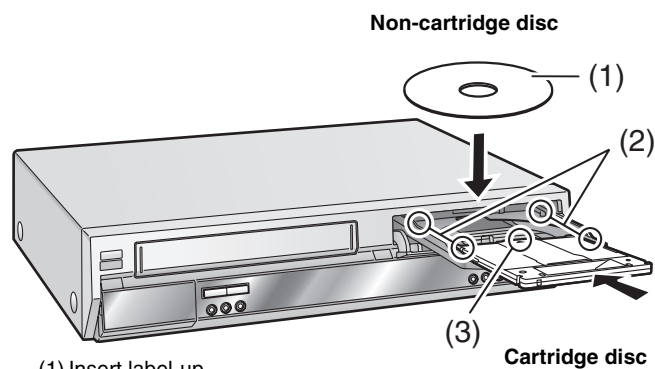

- (1) Insert label-up.
- (2) Insert inside the tray's guides.
- (3) Insert label-up with the arrow facing in.

Playing discs

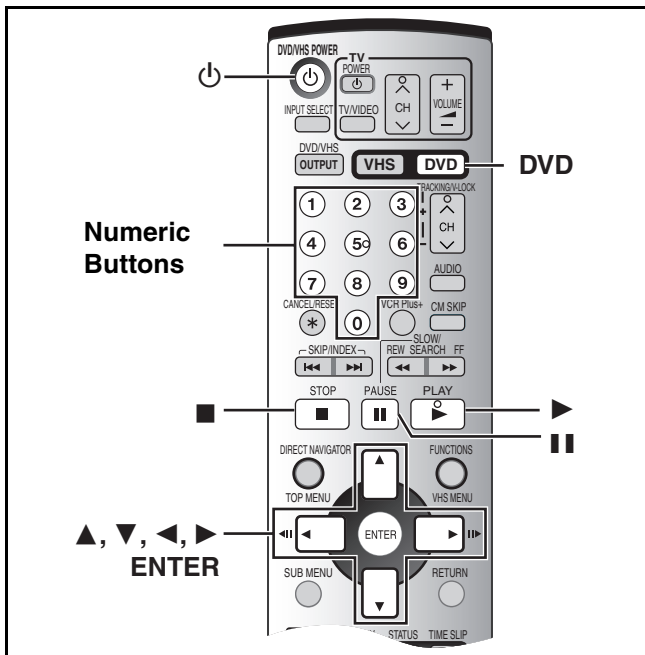

RAM DVD-R DVD-A DVD-V VCD CD MP3

Preparation

- Press [DVD].

- 1 Press [⏻, DVD/VHS POWER] to turn the unit on.
- 2 Insert a disc. (→ 20)
- 3 Press [▶, PLAY].

The disc tray closes and play begins.
(The unit takes some time to read the disc before play starts.)
• Playback starts from the most recently recorded title.

- Playback starts from the beginning of the disc.
- RAM DVD-R
DVD-A DVD-V VCD CD MP3

■ To stop play

Press [■, STOP]. (→ right, "Resume Function")

- A screen similar to the one on the right may appear when you stop play. Press [■, STOP] again and you can use this unit's tuner to watch TV. DVD-A DVD-V VCD CD MP3



■ To pause play

Press [⏸, PAUSE]. (Press again to restart play.)

■ When a menu screen appears on the TV

DVD-A DVD-V VCD

VCD

Press the numeric buttons to select an item.

e.g.: "5": [0]→[5]
"15": [1]→[5]

DVD-A DVD-V

Press [▲, ▼, ◀, ▶] to select an item and press [ENTER].

- You can also use the numeric buttons to select an item.

Other buttons used to operate menus

Read the disc's instructions for further details about operation.

Note

- If "⊘" appears on the TV, the operation is prohibited by the unit or disc.

Quick View (Play ×1.3)

RAM (Only with Dolby Digital)

The play speed can be increased without distorting the audio.



During Play

Press and hold [▶, PLAY].

■ To return to normal speed

Press [▶, PLAY].

Note

- Output is in PCM when using a digital connection (→ 12).
- This is cancelled when you perform skip, pause, or when play reaches a point where a program recorded in sound other than Dolby Digital starts.
- This does not work if the setting is "Off" in "Search Audio & PLAY ×1.3" (→ 44).
- This does not work when recording is in XP or FR mode during simultaneous recording and play (→ 25). RAM

Starting play from where you stopped it (Resume Function)

RAM DVD-R DVD-A DVD-V VCD CD MP3

1 During play

Press [■, STOP].

e.g.: Normal play



- "PB" flashes on the unit's display (Normal play only). The unit memorizes the position.

2 Press [▶, PLAY].

- Play starts from where you stopped it.

■ To cancel the resume function (Normal play only)

Press [■, STOP] while the unit remembers the position.

(The position is also cleared when you turn the unit off.)



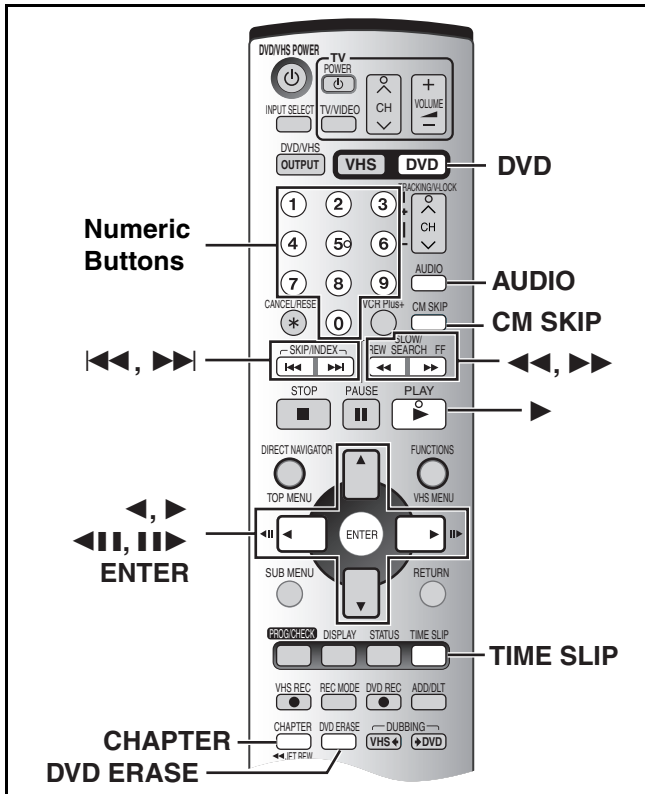

Preparation

- Press [DVD].

Fast forward and rewind—SEARCH

RAM DVD-R DVD-A DVD-V VCD CD MP3



During play

Press [**◀◀**, SLOW/SEARCH] or [**▶▶**, SLOW/SEARCH].

- On the main unit, press and hold [**◀◀/◀◀**] or [**▶▶/▶▶**].
- There are 5 search speeds. Each press increases the search speed.
- Press [**▶**, PLAY] to restart playback.
- Sound is output only in the first level of fast forward. In the case of DVD-A (except moving picture parts), CD and MP3, it is output in all levels.
- You can turn this sound off if you want to (→ 44, “Audio”—“Search Audio & PLAY ×1.3”).

Slow-motion play

RAM DVD-R DVD-A (Motion picture parts only) DVD-V VCD

While paused

Press [**◀◀**, SLOW/SEARCH] or [**▶▶**, SLOW/SEARCH].

- On the main unit, press and hold [**◀◀/◀◀**] or [**▶▶/▶▶**].
- When slow motion play is continued for about 5 minutes it pauses automatically.
- The speed increases up to 5 steps.
- Press [**▶**, PLAY] to restart playback.
- Forward direction ([**▶▶**], [**▶▶/▶▶**]) only. **VCD**

Frame-by-frame viewing

RAM DVD-R DVD-A (Motion picture parts only) DVD-V VCD

While paused

Press [**◀◀◀**], [**▶▶▶**], [**◀**] or [**▶**].

- Each press shows the next or previous frame.
- Press [**▶**, PLAY] to restart playback.
- Forward direction ([**▶▶▶**], [**▶**]) only. **VCD**

Skipping

RAM DVD-R DVD-A DVD-V VCD CD MP3

During play or while paused

Press [**◀◀◀**, SKIP] or [**▶▶▶**, SKIP].

- On the main unit, press [**◀◀/◀◀**] or [**▶▶/▶▶**].
- Each press increases the number of skips.

Direct Play

RAM DVD-R DVD-A DVD-V VCD CD MP3

Starting play from a selected title, chapter or track.

During play

Press the numeric buttons to select the item.

e.g.: “5”: [0]→[5] **MP3** “5”: [0]→[0]→[5]
 “15”: [1]→[5] “15”: [0]→[1]→[5]

DVD-A

A group number can be specified while the screen saver is displayed.

e.g.: “5”: [5]

Screen saver



- This works only when stopped (screen saver is displayed) with some discs.

Playing bonus groups

Some discs contain bonus groups. If a password screen appears after selecting a group, enter the password with the numeric buttons and press [ENTER]. Refer also to the disc's jacket.

CM Skip

RAM DVD-R

You can skip approximately 1 minute with one press.

During play

Press [**CM SKIP**].

Displaying the TV image as a picture-in-picture/ Selecting an amount of time to skip— Time Slip

RAM DVD-R

Skips the specified time.
Displays the TV image being received as a picture-in-picture.

1 During play

Press [TIME SLIP]. (Press again to cancel.)

- You will hear the playback audio.
- The blue background does not appear on the receiving screen even if you select “On” from “Blue Background” in the SETUP menu (→ 45).

2 Press [▲, ▼] to enter the time and press [ENTER].

- The time indicator will go off after about 5 seconds, but will turn on again when you set the indicator.
- Play skips the amount of time you entered.
- Press to alter in 1-minute units. Press and hold to alter in 10-minute units.

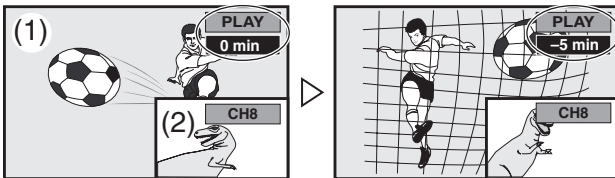

(1) Play images

(2) Current receiving images

- You can change the channel being received by pressing [CH, ▲, ▼].
- You cannot change the channel being received while recording.

■ To show the play images in full

Press [TIME SLIP].

Erasing a title that is being played

RAM DVD-R

You can erase titles while playing.

- A title cannot be restored once it is erased. Make certain before proceeding.

1 During play

Press [DVD ERASE].

2 Select “Erase” with [◀] and press [ENTER].

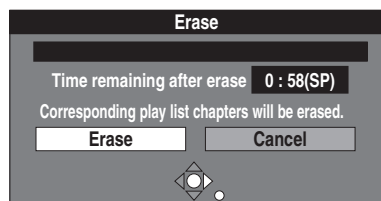

For your reference

- It is not possible to erase a title when you are carrying out simultaneous recording and play (→ 25). RAM
- It is not possible to erase a title that is in the process of being recorded.
- The available recording time on DVD-R does not increase when you erase titles.

Create chapters

RAM

1 During play

Press [CHAPTER].

- Press [◀◀, SKIP] or [▶▶, SKIP] to skip to the start of a chapter.
- You cannot activate this function when recording and playing at the same time.

Changing audio during play

RAM DVD-A DVD-V VCD

You can change the audio being played.

Press [AUDIO] to select the audio type.

RAM VCD (→ 47)

LR→L→R

↑

- When playing an SAP broadcast recorded in DVD-RAM: MAIN ↔ SAP

e.g.: RAM

“L R” is selected



DVD-A DVD-V (→ 40)

You can change the audio channel number by pressing [AUDIO]. This allows you to change items like the sound track language.



e.g.: DVD-V English is the selected language.

Note

If you cannot change the audio type when you have used only an optical digital cable for connection, set “Dolby Digital” to “PCM” (→ 44). Alternatively, you may connect to an amplifier with an Audio/Video cable and change the input on the amplifier to suit the connection.

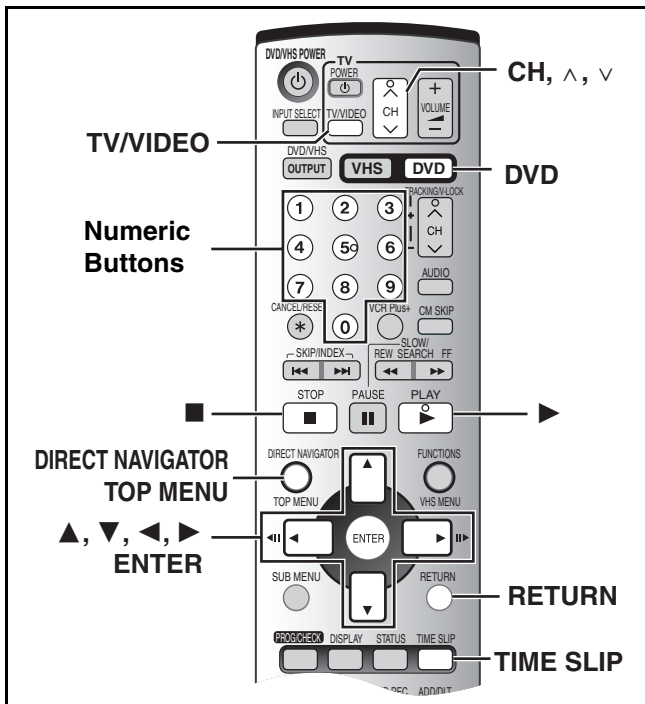

Preparation

- Press [DVD].

Using menus to play MP3 discs

MP3

This unit plays MP3 files recorded on CD-R/RW designed for audio recording that are finalized (→ 63) on a computer. Files are treated as tracks and folders are treated as groups.

- 1 During stop or play Press [TOP MENU].

- The file list appears.

G: Selected Group No. and Name
The Group Number

T: Track Number in the Group

TOTAL: Selected Track Number/
Total Track Number

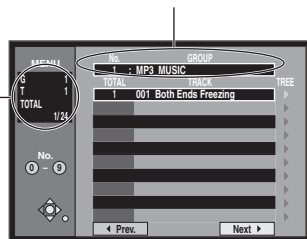

- 2 Press [▲, ▼] to select the track and press [ENTER].

Play continues to the last track in the last group.

- “□” indicates the track currently playing.
- You can also directly select the track with the numeric buttons.
e.g.: The track “006.mp3” of Group “002” in the illustration on the right,
“6”: [0] → [0] → [6]
- The track “010.mp3” of Group “003” in the illustration on the right,
“10”: [0] → [1] → [0]

■ To show other pages

Select “◀ Prev.” or “Next ▶” with [▲, ▼, ◀, ▶] and press [ENTER].

- After listing all the tracks in one group, the list for the next group appears.

■ To exit the file list

Press [TOP MENU] or [RETURN].

■ Using the tree screen to find a group

- 1 While the file list is displayed Press [▶] while a track is highlighted to display the tree screen.



Selected Group Number/Total Group Number

- If the group has no track, “- -” is displayed as group number.

- A folder which has no MP3 files is indicated in black. You cannot select groups with no MP3 files.

- 2 Press [▲, ▼] to select a group and press [ENTER].

- The file list for the group appears.

For your reference

- Press [◀, ▶] to jump layers in the tree screen.

■ To return to the file list

Press [RETURN].

■ Tips for making MP3 discs

- Discs must conform to ISO9660 level 1 or 2 (except for extended formats).
- Compatible compression rate: from 32 kbps to 320 kbps
- Compatible sampling rate: 16 kHz, 22.05 kHz, 24 kHz, 32 kHz, 44.1 kHz, 48 kHz
- Maximum number of tracks and groups recognizable: 999 tracks and 99 groups
- This unit is compatible with multi-session.
- This unit is not compatible with ID3 tags or packet writing.
- Depending on recording, some items may not be playable.
- Reading or play of the disc may take time if there are a lot of still pictures or sessions.
- The display order may differ from how the order is displayed on a computer.

■ Naming folders and files

At the time of recording, give folder and file names a 3-digit numeric prefix in the order you want them to play (this may not work at times).

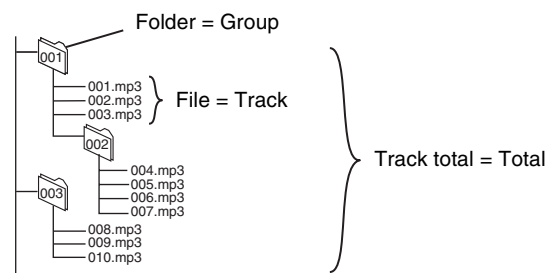

- MP3 files must have the extension “.MP3” or “.mp3”.
- English alphabet and Arabic numerals are displayed properly. Other characters may not be displayed properly.

Playing while you are recording

RAM

Preparation

- Press [DVD].

Hint

- Sound is not output while fast-forwarding.

Chasing play

You can start play from the beginning of the title while continuing to record it.

While recording or timer recording

Press [▶, PLAY].

Time Slip indicator on the main unit lights.

For your reference

- Play cannot be started until at least 2 seconds after recording starts.

Simultaneous recording and play

You can start play of the title you are recording or play a title previously recorded.

While recording or timer recording

1 Press [DIRECT NAVIGATOR].

2 Use [▲, ▼, ◀, ▶] to select a title and press [ENTER].

- Time Slip indicator on the main unit lights.

●: Currently recording

e.g.:

You want to watch the movie you recorded yesterday (title 08) while recording sport (title 09).

Title 08 is played back while title 09 is being recorded.

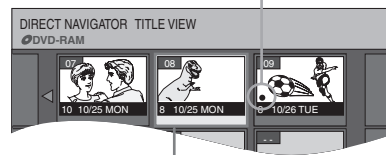

Selecting title 08

To exit the Direct Navigator screen

Press [DIRECT NAVIGATOR].

For your reference

- During simultaneous recording and play, you cannot edit or erase with the Direct Navigator or play lists.
- If you start play while the unit is on standby for timer recording, recording starts when the time you set is reached.

TIME SLIP

You can play the title being recorded to check that it is being recorded correctly. You can also check parts that were recorded previously.

While recording or timer recording

1 Press [TIME SLIP].

Time Slip indicator on the main unit lights. Play starts from 30 seconds previous to that moment. What is currently being recorded appears as a picture-in-picture and you will hear the playback audio.

- (1) Play images (30 seconds before)
- (2) Current recording

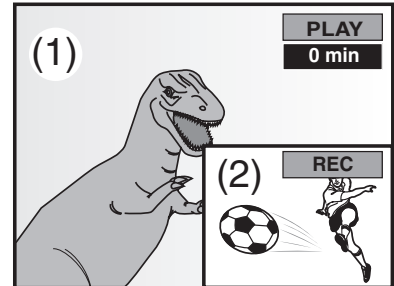

2 Press [▲, ▼] to select the time and press [ENTER].

- The time indicator will go off after about 5 seconds, but will turn on again when you set the indicator.
- Press [▲, ▼] to alter in 1-minute units. Press and hold [▲, ▼] to alter in 10-minute units.



To show the play images in full

Press [TIME SLIP].

- Press [TIME SLIP] to return to the picture-in-picture screen.

For your reference

- The image on the small screen may be distorted or flicker depending on the scene. However, this does not affect the image recorded.

To stop play and recording

1 Press [■, STOP]. Play stops.

(Wait 2 or more seconds)

2 Press [■, STOP]. Recording stops.

- You cannot stop recording with [■, STOP] during timer recording. To stop timer recording, press [■, STOP], then [ENTER] within 5 seconds.
- You can also press and hold [■] on the main unit for more than 3 seconds to stop timer recording.

Watching the TV while recording

1 Press [TV/VIDEO] to change the input mode to "TV".

2 Press TV's [CH, ▲, ▼] to select the desired TV channel.

For your reference

- You can also do this if the unit is making a timer recording.
- The recording is unaffected.

Recording modes and approximate recording times

Depending on the content being recorded, the recording times may become shorter than indicated.

(Unit: hour)

	DVD-RAM		DVD-R (4.7 GB)
	Single-sided (4.7 GB)	Double-sided (9.4 GB)	
XP (High quality)	1	2	1
SP (Normal)	2	4	2
LP (Long play)	4	8	4
EP (Extra long play)	8 (6*)	16 (12*)	8 (6*)

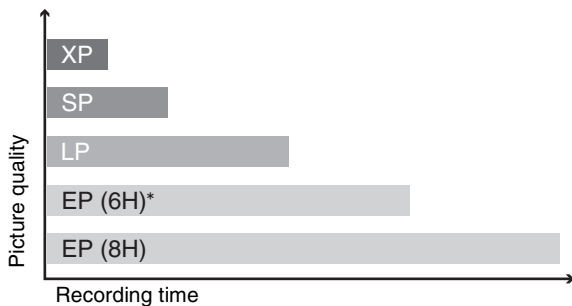

* When "Recording Time in EP Mode" has been set to "EP (6H)" in the SETUP menu (→ 43).

The sound quality is lower compared to other recording modes when using "EP (8H)".

Note

When recording to DVD-RAM using EP (8H) mode, play may not be possible on DVD players that are compatible with DVD-RAM. In this case use EP (6H) mode.

FR (Flexible Recording mode):

The unit automatically selects a recording rate between XP and EP (8H) that will enable the recordings to fit in the available recording time on the disc with the best possible recording quality.

- You can use this function in manual transfer (→ 59) or timer recording (→ 28).
- All recording mode indicators on the unit's display are lit during FR.

Selecting audio to record

RAM

Preparation

- Press [DVD].

Press [AUDIO].

- Stereo:** Main audio (stereo)
 - If the broadcast is "Mono+SAP", audio will be monaural even if you select Stereo mode.
- SAP:** Secondary audio program (SAP)
 - If recorded in SAP mode, main audio is also recorded.
- Mono:** Main audio (monaural)
 - Select "Mono" if reception is poor during a stereo broadcast.

e.g., "Stereo" is selected.
 ("(" appears when the unit is receiving the audio type you selected.



- If you change the sound setting while recording, the recorded sound will also change.

DVD-R

Select the audio (Main or SAP) in "Select MTS" in the SETUP menu (→ 44).

Flexible Recording mode (FR)

RAM DVD-R

The unit calculates a recording rate that enables the recording to fit in the time you set (within the remaining time on the disc) with the best picture quality.

e.g.: disc is DVD-RAM

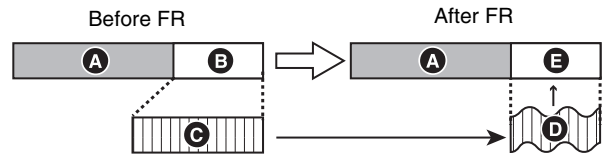

- A** Recorded
- B** Remained (45 min.)
 - Recordable for 45 minutes in SP mode
- C** Program to be recorded (The program is 60-minute long.)
- D** The recording mode automatically switches from SP to LP according to the remaining time.
- E** The program exactly fits into the remaining time.

Preparation

- Press [DVD].
- Select the channel to record.

1 While stopped

Press [FUNCTIONS]. (→ 47)

2 Select "FLEXIBLE RECORDING" with [▲, ▼, ◀, ▶] and press [ENTER].

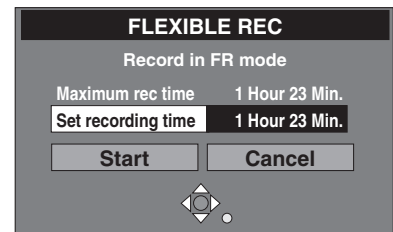

3 Press [▲, ▼, ◀, ▶] to set the recording time.

- You can also set the recording time with the numeric buttons.
- Maximum recording time is 8 hours.

4 Select "Start" with [▲, ▼, ◀, ▶] and press [ENTER].

- Recording starts.

For your reference

- It is not possible to change channel or recording mode while Flexible Recording is paused.

To exit the FLEXIBLE REC window without recording

Press [RETURN].

To stop recording partway

Press [■, STOP].

To show the time remaining until recording finishes

Press [STATUS] several times.

- It is displayed in units of minutes.

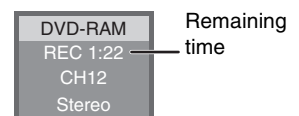

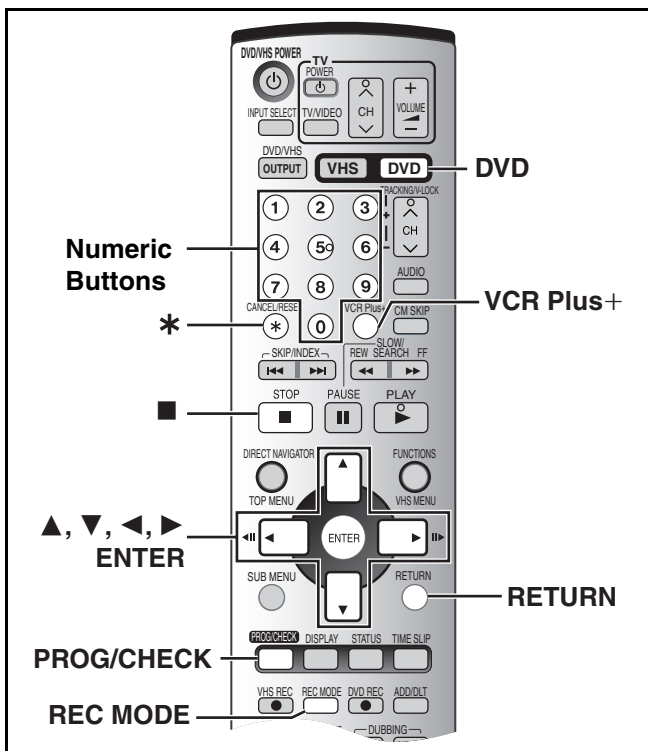

RAM DVD-R

Caution for Timer recording

- Timer recording automatically starts at the set time.
- Timer recording can be started whether the unit is turned on or off. When the unit is turned off, the sound and the video cannot be outputted to the TV.

You can enter up to 16 programs up to a month in advance.

Preparation

- Release protection (disc → 30, cartridge → 18). **RAM**
- Insert a disc (→ 20) and confirm there is sufficient empty space for recording on it (→ 47).
- Press [DVD].

Using VCR Plus+ system

Entering the PlusCode numbers is an easy way of timer recording. You can find these codes in TV listings in newspapers and magazines.

- When connecting a cable TV box or satellite receiver, the VCR Plus+ system does not work. Program the timer recording manually (→ right).

1 Press [VCR Plus+].

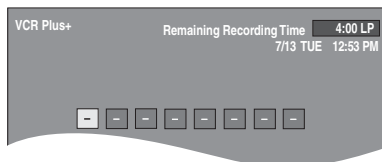

2 Press the numeric buttons to enter the PlusCode number.

- Press [◀] to move back to correct a digit.

3 Press [ENTER].

- Confirm the program and correct it if necessary using [▲, ▼, ◀, ▶] (→ right, step 3).
- When "XP" is

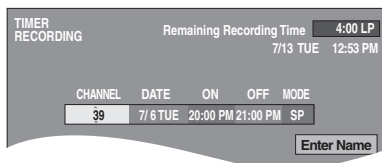

- displayed in the unit's display, the recording mode automatically changes to "FR" in order to prevent loss of recording when there is not enough space. Change to "XP" mode if you want to set timer recording using "XP" mode.

- "Invalid Entry" is displayed when you enter the wrong PlusCode number. Reenter the PlusCode number.

To enter the title of the program

- Press [◀, ▶] to select "Enter Name" and press [ENTER] (→ 32).

4 If the program is correct Press [ENTER].

- "Ⓞ" lights on the unit's display.

- Repeat steps 1–4 to program other recordings.



Check to make sure "OK" is displayed.

5 Press [RETURN].

Manual programming

- When connecting a cable TV box or satellite receiver, select the channel on the cable TV box or satellite receiver before timer recording starts.

1 Press [PROG/CHECK].

- Make sure "New Timer Program" is selected.

Highlighted line is ready for programming.

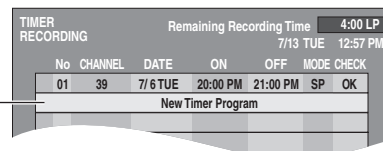

2 Press [ENTER].

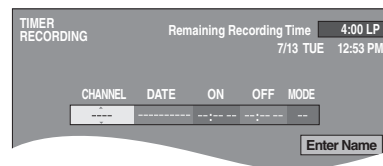

3 Use [▶] to move and change the items with [▲, ▼].

- You may use the numeric buttons to enter "CHANNEL", "DATE", "ON" and "OFF".

- CHANNEL** (Program Position/TV Station Name)
- DATE**

You can also make a daily or weekly program. Each daily or weekly program is counted as one program.

- ON** (start time)/**OFF** (finish time)

The time increases or decreases in 30-minute increments if you hold down the button.

- MODE** (Recording mode)

You can also press [REC MODE] to change the recording mode.

XP↔SP↔LP↔EP↔FR↔XP... (→ 27)

- Enter Name**

- Press [◀, ▶] to select "Enter Name" and press [ENTER] (→ 32).

4 Press [ENTER] when you have finished making changes.

- "Ⓞ" lights on the unit's display.

- To continue programming:

Select "New Timer Program" and repeat steps 2–4.

5 Press [RETURN].

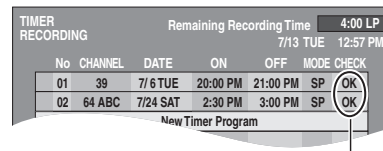

Check to make sure "OK" is displayed.

Note

- “⊖” flashes when the unit cannot perform timer recording (non-recordable disc or protected disc, etc.). Check the disc carefully.
- The actual time recorded may be longer than the program itself when TV programs are recorded using VCR Plus+ system.
- When recording more than one program in a row, for DVD-RAM the first few seconds, and for DVD-R about the first 30 seconds of all programs from the second one onwards will not be recorded.
- If you set “DST” (Daylight Saving Time) to “ON” when manually setting the clock (→ 46), timer recording may not work when summer switches to winter and vice versa.
- When the unit is carrying out a timer recording:
 - You may utilize playback.
- When the disc is not inserted, the disc is full or a non-recordable disc is inserted, the warning message appears because Timer Recording is disabled.

To stop recording while a program is working

Press [■, STOP], then [ENTER] within 5 seconds.

- You can also press and hold [■] on the main unit for more than 3 seconds to stop recording.

Preparation

- Press [DVD].

Check, change or delete programs

- Even when the unit is turned off, you can display the timer recording list by pressing [PROG/CHECK].

Preparation

- Press [DVD].

1 Press [PROG/CHECK].

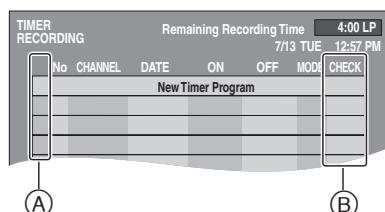

Icon explanations (A)

- Now recording
- ⊖ Programs are overlapped. Recording of the program with the later start time starts before the earlier program finishes recording.
- ⊘ You stopped a weekly or daily timer recording. The icon disappears the next time the timer starts recording.
- ⊕ The disc was full. (no enough space)
- ⊗ The TV program is not allowed to record by copy-guard.
- ⊗ Recording stopped (Dirty disc, etc.)

CHECK (B)

OK: Recordable

→ (Date): The last day of daily or weekly recording.

!: Recording stopped (no disc or protected disc, etc.)

2 Press [▲, ▼] to select the program.

- You may also select program by inputting a 2-digit number using the numeric buttons.

e.g.: “5”: [0]→[5]

“15”: [1]→[5]

- Use [◀, ▶] to move to the preceding or following page.

3 Press [CANCEL/RESET, *] to delete,

You cannot delete programs that are currently recording.

or press [ENTER] to change.

The timer recording setting screen appears.

4 If you pressed [ENTER] in step 3,

Use [▲, ▼, ▶, ◀] to change and press [ENTER].

5 Press [RETURN].

For your reference

- Programs that failed to record are not deleted from the list immediately (indicated in gray), but are deleted from the list automatically at 4 a.m. two days later.
- During timer recording, you can change the end time as long as the recording mode is not “FR”.

Cautions for using timer recording on DVD and VHS

Timer recording for TV programs cannot be executed on both DVD and VHS at the same time.

Make sure the timer recording start times do not overlap on both DVD (→ left) and VHS (→ 53) timer-programming screens.

When the timer recording settings overlap:

- When the start time of both timer recordings is the same, the timer recording of DVD has priority.
- When tuner channels are specified in timer recordings on both VHS and DVD, only one timer recording can be started.
- When the interval between the first timer recording and the second timer recording on DVD is 1 minute or less as shown below, the second timer recording on DVD has priority over the timer recording on VHS even if its start time is later than the timer recording on VHS.

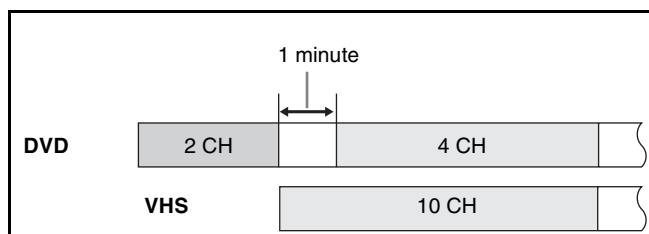

DISC SETTING

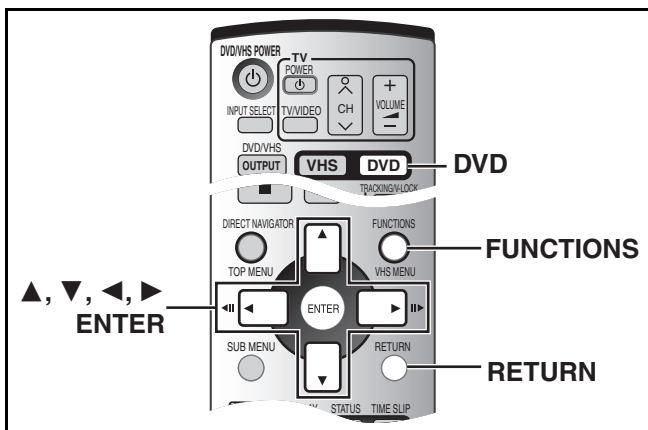

RAM **DVD-R**

Preparation

- Release protection (disc → below, cartridge → 18). **RAM**
- Press [DVD].

- 1 While stopped Press [FUNCTIONS]. (→ 47)**

e.g., DVD-RAM

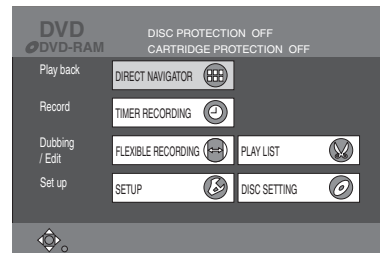

- 2 Select "DISC SETTING" with [▲, ▼, ◀, ▶] and press [ENTER].**

e.g., DVD-RAM

e.g., DVD-R

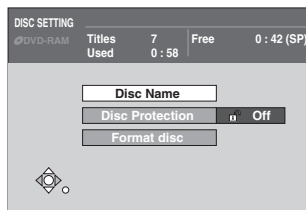

- 3 Use [▲, ▼] to select a desired item and press [ENTER].**

After this operation, follow the desired operation.

■ To stop midway
Press [RETURN].

▶ Disc Name

RAM **DVD-R**

Refer to "Entering text". (→ 32)

- The disc name is displayed in the FUNCTIONS window.



Note

- You cannot give DVD-R titles once they have been finalized.

▶ Disc Protection

RAM

This allows you to protect discs from accidental erasure.
This allows you to release disc protection.

- 4 Select "Yes" with [◀] and press [ENTER].**

- To protect

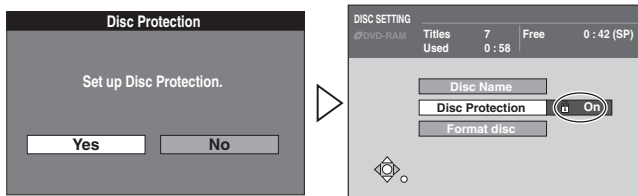

- To release protection

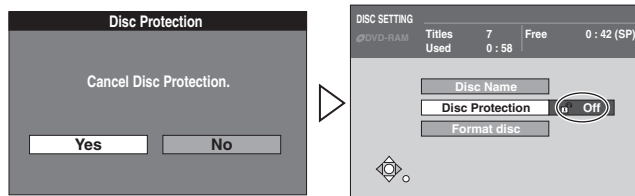

▶ Format disc

RAM

Some DVD-RAM are unformatted. You must format these discs before using them in this unit. Formatting also allows you to erase the entire contents of a disc.

4 Select “Yes” with [◀] and press [ENTER].

5 Select “Start” with [◀] and press [ENTER].

- Formatting starts.
- A message appears when formatting is finished.

6 Press [ENTER].

Once the disc has been formatted, the contents cannot be restored. Check carefully before proceeding. The contents on the disc are erased when you format it even if you have set title or disc protection.

Note

- **Do not turn the unit off or disconnect the AC power supply cord while the message “Formatting the disc” is on the TV. This can render the disc unusable.** (This can take up to max. 70 minutes (DVD-RAM). If it takes more than 2 minutes, you can cancel formatting by pressing [RETURN]. The disc must be reformatted if you do this.)
- All data on the disc is erased when it is formatted, including recordings made with this unit. Data written to the disc by a computer is also erased.
- The disc cannot be formatted if the write protect tab (→ 18) is switched to “PROTECT”. Release the protection to continue.
- The message “Unable to format” appears when trying to format discs this unit cannot use.

For your reference

- DVD-R and CD-R/RW cannot be formatted.

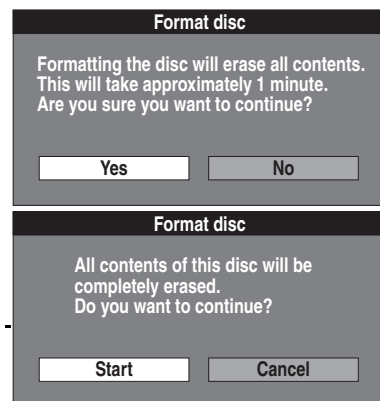

▶ Select First play

DVD-R

Select whether to show the top menu after finalizing the disc. Do this before finalizing the disc.

4 Use [▲, ▼] to select a desired item and press [ENTER].

- Top Menu: The top menu appears first.
- Title 1: The disc content is played without displaying the top menu.

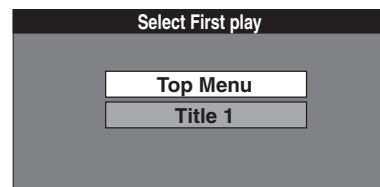

▶ Finalize

DVD-R

You can play DVD-R on compatible DVD players by finalizing them on this unit, effectively making them into DVD-Video that complies with DVD-Video standards.

The menu you create with this unit can also be used on the player.

4 Select “Yes” with [◀] and press [ENTER].

5 Select “Start” with [◀] and press [ENTER].

- Finalizing starts.
- A message appears when finalizing is finished.

6 Press [ENTER].

Note

- **Do not turn the unit off or disconnect the AC power supply cord while the message “Finalizing the Disc” is on the TV. This can render the disc unusable.**
- Finalizing takes up to about 15 minutes.
- You can only finalize DVD-R that were recorded on this unit.
- You cannot record on DVD-R that have been finalized.
- After finalizing
 - The disc becomes play-only and you can no longer record or edit it.
 - DVD-R finalized on this unit may not be playable on other players due to the condition of the recording.
 - There is a pause of several seconds between titles.
 - Titles are divided into about 5-minute* chapters.
 - * This time varies greatly depending on the condition and mode of recording.
- Visit Panasonic’s homepage for more information about DVDs.
For U.S.A.: <http://www.panasonic.com/playDVD-R>
For Canada: <http://www.panasonic.ca>

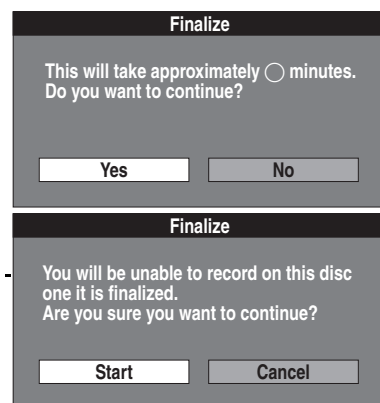

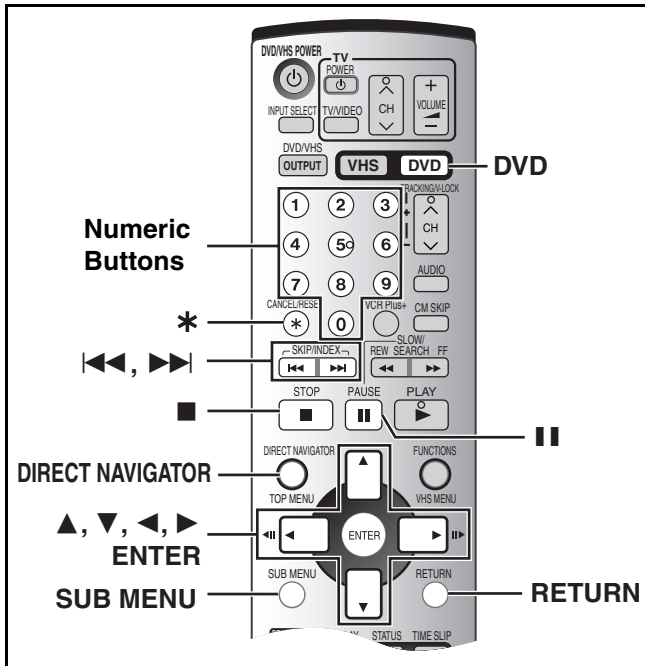

- (3) SET (when you have finished entering text) [■], STOP]
- (4) SPACE
- (5) The title displayed on the menu screen after finalizing the DVD-R appears. **DVD-R** (→ 34)

To enter other characters

Repeat step 1.

2 Press [■, STOP].

The title is entered and the screen disappears.

- You can also finish entering the title by selecting "SET" with [▲, ▼, ◀, ▶] and pressing [ENTER].

Regarding entering characters

To erase characters

Press [■, PAUSE]. (You can also erase characters by selecting "ERASE" with [▲, ▼, ◀, ▶] and pressing [ENTER].)

To enter a space

You may enter a space by pressing [*] and then press [ENTER].

Using the numeric buttons to enter characters

e.g., entering the letter "R"

- 1 Press [7] to move to the 7th row.
- 2 Press [7] twice to highlight "R".
- 3 Press [ENTER].



To correct a character

- 1 Use [▲, ▼, ◀, ▶] to select the character you want to correct in the name field.
- 2 Press [■, PAUSE]. (You can also erase characters by using [▲, ▼, ◀, ▶] to select "ERASE" and pressing [ENTER].)
- 3 Use [▲, ▼, ◀, ▶] to select the correct character and press [ENTER].

Note

- If you enter a long name, it is partially shown in the title list (→ 33) and play list screen (→ 37).

To cancel partway

Press [RETURN].

- Text is not saved.

Entering text

RAM | DVD-R

You can give names to recorded titles, etc.

The maximum number of characters:

RAM	Characters
• Title	64
• Title (timer recording)	44
• Play list	64
• Disc	64
DVD-R	Characters
• Title	44
• Disc	40

If a name is long, parts of it may not be shown on some screens.

Preparation

- Insert a recorded disc.
- Release protection.
 - Disc (→ 30), title (→ 34), cartridge (→ 18) **RAM**
- Press [DVD].

Refer to the following pages regarding display of the Enter Name Screen.

- Title (→ 34).
- Title (timer recording) (→ 28).
- Disc (→ 30).
- Play list (→ 38).

1 After the Enter Name screen appears

Use [▲, ▼, ◀, ▶] to select the character you want to enter and press [ENTER].

- You can enter the following characters.

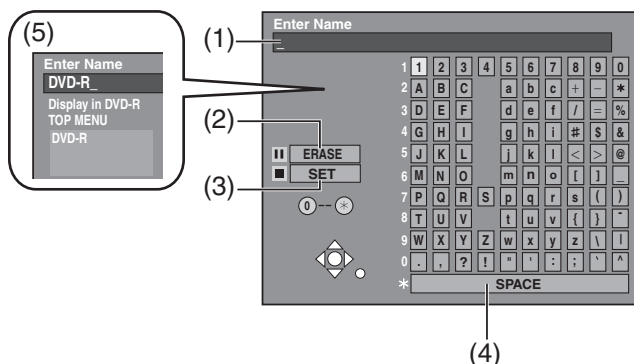

- (1) This window shows the text you have entered. (Name field)
- (2) ERASE [■, PAUSE]

Using the Direct Navigator

RAM DVD-R

Title/Chapter
Programs are recorded as a single title consisting of one chapter.

You can divide a title into multiple chapters. **RAM**
(→ 23, "Create chapters", → 35, "Divide Chapter")

You can change the order of chapters and create a play list. **RAM**

- Titles are divided into about 5-minute chapters after finalizing (→ 31). **DVD-R**

- The maximum number of items on a disc:
 - Titles: 99
 - Chapters: Approximately 1000 (Depends on disc contents.)

Note

- Once erased or shortened, the title cannot be restored to its original state. Make certain before proceeding.
- You cannot edit during recording.

Direct Navigator screen icons

- 🔒 : Title protected
- 🔒 : Copy-protected so it was not recorded.
- X: Unable to play
- : Currently recording

Direct Navigator

Preparation

- Release protection (disc → 30, cartridge → 18). **RAM**
- When the title is protected (→ 34), you can only access "Properties" and "Cancel Protection". Release the protection to access other items. **RAM**
- Press [DVD].

- 1 Press [DIRECT NAVIGATOR].
- 2 Use [▲, ▼, ◀, ▶] to select a desired title.
 - "To show other pages", → above

Selecting recorded titles to play

Preparation

- Insert a disc that has been recorded on.
- Press [DVD].

- 1 Press [DIRECT NAVIGATOR].

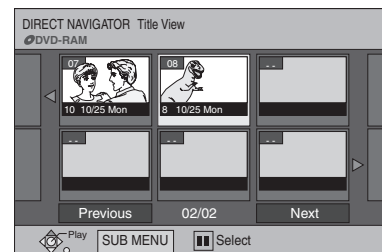

- 2 Use [▲, ▼, ◀, ▶] to select the title you want to watch and press [ENTER].

- You can also select titles by entering a 2-digit number with the numeric buttons.
e.g.: "5": [0]→[5]
"15": [1]→[5]
- If you enter a number larger than the total number of titles, the last title is selected.

To show other pages

Press [▲, ▼, ◀, ▶] to select "Previous" or "Next" and press [ENTER].

- You can also press [◀◀, SKIP] or [▶▶, SKIP] to show other pages.

For your reference

- The Direct Navigator works while stopped, playing or recording.

To clear the title list

Press [RETURN].

Multiple editing

Select with [▲, ▼, ◀, ▶] and press [■, PAUSE]. (Repeat)
A check mark appears. Press [■, PAUSE] again to cancel.

- 3 Press [SUB MENU].
- 4 Use [▲, ▼] to select a desired item and press [ENTER].

To stop partway

Press [RETURN].

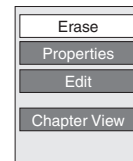

▶ Erase

RAM DVD-R (Multiple editing is possible.)

The title is irretrievably erased when you use this procedure and cannot be retrieved. Check the title carefully before erasing to ensure it isn't one you want to keep.

- 5 Select "Erase" with [◀] and press [ENTER].

For your reference

- The disc's available recording time may not increase after erasing short titles.
- The available recording time on DVD-R does not increase when you erase titles.

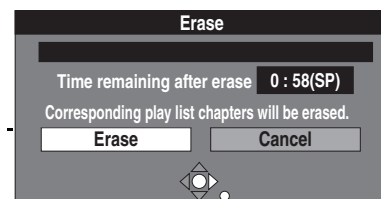

▶ Properties

RAM DVD-R

You can check the contents of a selected title.



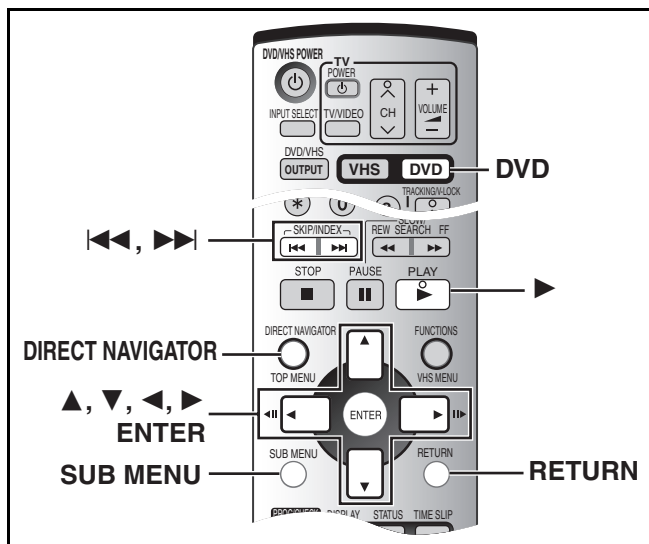

Preparation

- Release protection (disc → 30, cartridge → 18). **RAM**
- Press [DVD].

- 1 Press [DIRECT NAVIGATOR].
- 2 Use [▲, ▼, ◀, ▶] to select a desired title.
 - “To show other pages”, → 33
 - “Multiple editing”, → 33
- 3 Press [SUB MENU].
- 4 Use [▲, ▼] to select a desired item and press [ENTER].

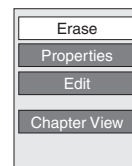

- To stop partway
Press [RETURN].

Edit

Edit Sub menu displayed.

- 5 Use [▲, ▼] to select the desired item and press [ENTER].

e.g.: DVD-RAM



▶▶ Enter Name

RAM DVD-R

Refer to “Entering text”. (→ 32)

For your reference

- The full name is shown in the “Properties” screen, but if you enter a long name, only part of it is shown in the title list.

▶▶ Set up Protection

RAM (Multiple editing is possible.)

You can prevent accidental erasure of titles by write-protecting them.

- 6 Select “Yes” with [◀] and press [ENTER].

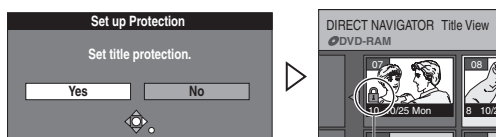

The padlock mark appears.

For your reference

Titles will be erased even if they are protected if you format the disc with DISC SETTING (→ 31).

▶▶ Cancel Protection

RAM (Multiple editing is possible.)

- 6 Select “Yes” with [◀] and press [ENTER].

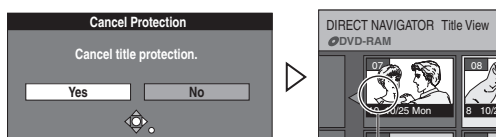

The padlock mark disappears.

▶▶ Shorten

RAM

You can remove unnecessary parts of the recording such as commercials.

- 6 Press [ENTER] at the start point and end point of the section you want to erase. (→ 35, “For quicker editing”)
- 7 Select “Exit” with [▲, ▼] and press [ENTER].
- 8 Select “Erase” with [◀] and press [ENTER].



■ To erase another part of the same title

After storing the point in “Start” and “End”, select “Next” in step 6 and perform step 8, then repeat steps 6–8.

For your reference

- You may not be able to specify start and end points within 3 seconds of each other.
- You cannot specify start and end points if the picture recorded is stilled.
- The unit pauses when the title reaches its end during this procedure.
- The disc’s available recording time may not increase after erasing short parts of titles.

▶▶ Change Thumbnail

RAM DVD-R

You can change the image to be shown as a thumbnail picture in the Title View.

- 6 Press [▶, PLAY] to play.
- 7 Press [ENTER] at the point you want to display. (→ 35, “For quicker editing”)
 - To change to another point in the same title:
 - Select “Change” with [▲, ▼] and press [▶, PLAY], and then repeat steps 7–8.
- 8 Select “Exit” with [▲, ▼] and press [ENTER].
 - The displayed scene is changed at this point.

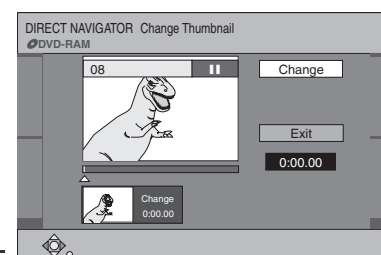

For your reference

- You cannot select the top and end of the title.

▶▶ Divide Title

RAM

You can divide a selected title into two. You must make sure when dividing a title because it cannot be recovered after the procedure.

- 6 Press [ENTER] at the point you want to divide the title.** (→ below, "For quicker editing")
 - To change the point to divide:
 - Select "Divide" with [▲, ▼] and press [▶, PLAY], and then repeat steps 6–8.

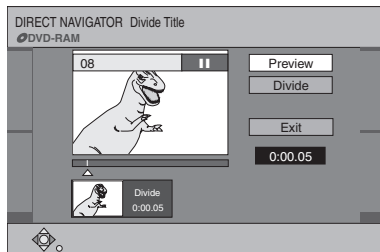

- 7 Select "Exit" with [▲, ▼] and press [ENTER].**

- 8 Select "Divide" with [◀] and press [ENTER].**

- The title is divided at the point.

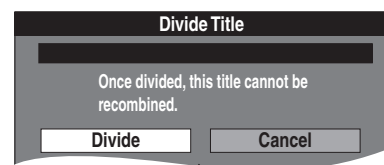

■ To check the division point

By selecting "Preview" in step 6 and pressing [ENTER], play will begin from 10 seconds prior to the division point to 10 seconds after the division point. You can make sure that the division point is appropriate.

For your reference

- The divided titles retain the name of the original title. They also retain the CPRM property (→ 18) of the original.
- Use search and slow-motion to find the points.
- It is not possible to carry out "Divide" in the following cases:
 - When the resulting part(s) are extremely short.
 - When the total number of titles is more than 99.

▶ Chapter View

- 5 Use [▲, ▼, ◀, ▶] to select the desired chapter.**

- To start play → Press [ENTER].
- To edit → Follow the steps below.

- 6 Press [SUB MENU]**

- 7 Use [▲, ▼] to select a desired item and press [ENTER].**

e.g.: DVD-RAM

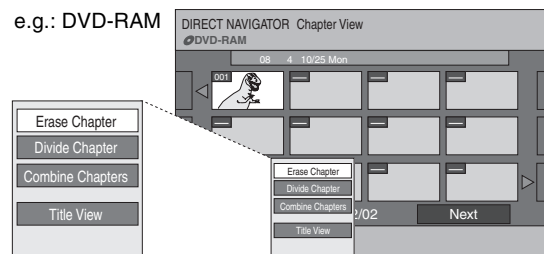

▶▶ Erase Chapter

RAM (Multiple editing is possible.)

- 8 Select "Erase" with [◀] and press [ENTER].**

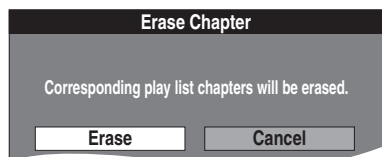

▶▶ Combine Chapters

RAM

- 8 Select "Combine" with [◀] and press [ENTER].**

- The selected chapter and next chapter are combined.

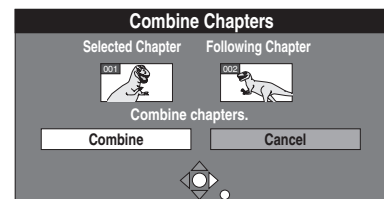

▶▶ Divide Chapter

RAM

- 8 Press [ENTER] at the point you want to divide.**

(→ below, "For quicker editing")

- Repeat this step to divide at other points.



- 9 Select "Exit" with [▼] and press [ENTER].**

Note

- A little portion of the recording directly preceding the division point may be lost.

For your reference

- The divided titles retain the name of the original title. They also retain the CPRM property (→ 18) of the original.
- It is not possible to carry out "Divide", when the resulting part(s) are extremely short.

▶▶ Title View

RAM DVD-R

Go back to Title View.

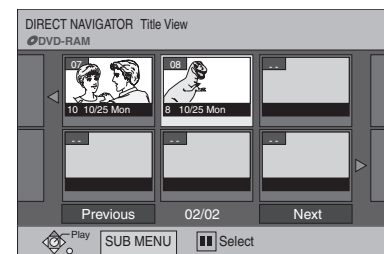

For quicker editing

- Use search (→ 22), Time Slip (→ 23) or slow-motion (→ 22) to find the desired point.
- Press [◀◀, SKIP] or [▶▶, SKIP] to skip to the end of a title.

Using play list

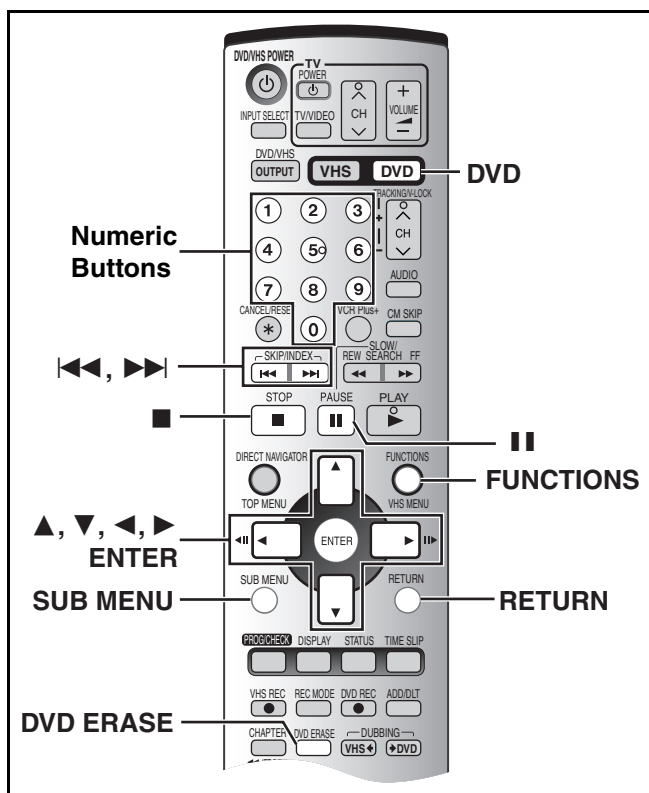

2 Select "PLAY LIST" with [▲, ▼, ◀, ▶] and press [ENTER].

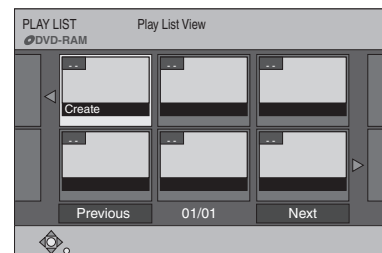

3 Select "Create" with [▲, ▼, ◀, ▶] and press [ENTER].

4 Use [◀, ▶] to select the source title and press [▼].

■ When you want to select all chapters in the title:

- Use [◀, ▶] to select the source title and press [ENTER], then skip to step 6.
- Repeat 4-6 to add other titles or chapters.

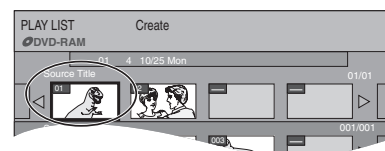

5 Use [◀, ▶] to select the chapter you want to add to a play list and press [ENTER].

- Press [▲] to cancel.



- You can also create a new chapter from the source title. Press [SUB MENU] to select "Divide Chapter" and press [ENTER] (→ 35, "Divide Chapter").

6 Use [◀, ▶] to select the position to insert the chapter and press [ENTER].



- Repeat steps 5-6 to add other chapters.
- Press [▲] to select other source titles.

7 Press [RETURN].

■ To stop partway through

Press [RETURN].

■ To clear the play list screen

Press [RETURN].

For your reference

- You may not be able to specify start and end points if the material is still pictures recorded on other equipment.

RAM

You can create a play list by gathering your favourite chapters (→ 33) from your recordings. You can also edit the created play list.

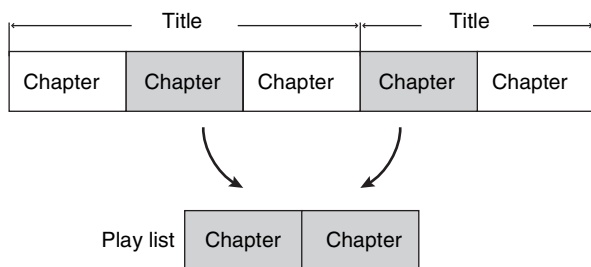

- Editing play lists doesn't modify the recorded data.
- Play lists are not recorded separately so this doesn't use much capacity.

- The maximum number of items on a disc:
 - Titles: 99
 - Chapters: Approximately 1000 (Depends on disc contents.)

■ Creating play lists

Preparation

- Release protection (disc → 30, cartridge → 18).
- Press [DVD].

1 While stopped Press [FUNCTIONS]. (→ 47)

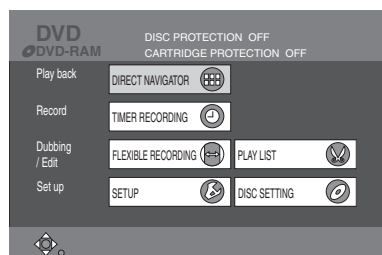

■ Playing play lists

RAM

Preparation

- Create play list first (→ 36).
- Press [DVD].

1 While stopped

Press [FUNCTIONS]. (→ 47)

2 Select "PLAY LIST" with [▲, ▼, ◀, ▶] and press [ENTER].

3 Press [▲, ▼, ◀, ▶] to select the play list and press [ENTER].

- You can also select a playlist from the chapter view by entering a 2-digit number with the numeric buttons.
e.g.: "5": [0]→[5]
"15": [1]→[5]

- If you enter a number larger than the total number of play lists, the last play list is selected.

To show other pages

Press [▲, ▼, ◀, ▶] to select "Previous" or "Next" and press [ENTER].

- You can also press [◀◀, SKIP] or [▶▶, SKIP] to show other pages.

■ To stop play list play

Press [■, STOP]. (The play list appears.)

■ To erase a play list during play

- 1 Press [DVD ERASE].
 - A confirmation message will be displayed.
- 2 Use [◀] to select "Erase" and press [ENTER].

■ Using play list to edit play lists/chapters

RAM

Preparation

- Create play lists first (→ 36).
- Release protection (disc → 30, cartridge → 18).
- Press [DVD].

For your reference

- You can use fast-forward, rewind, pause, and slow-motion while playing chapters just as you can during normal play.

1 While stopped

Press [FUNCTIONS]. (→ 47)

2 Select "PLAY LIST" with [▲, ▼, ◀, ▶] and press [ENTER].

- Chapters are not displayed if you have not yet created a play list with the disc.

3 Press [▲, ▼, ◀, ▶] to select the play list.

- "To show other pages", → above

Multiple editing

Select with [▲, ▼, ◀, ▶] and press [■, PAUSE]. (Repeat)
A check mark appears. Press [■, PAUSE] again to cancel.

4 Press [SUB MENU], then use [▲, ▼] to select the operation and press [ENTER].

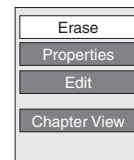

■ To clear the play list screen

Press [RETURN].

■ To stop partway

Press [RETURN].

▶ Erase

(Multiple editing is possible.)

5 Select "Erase" with [◀] and press [ENTER].

The play list is erased.

- Once a play list has been erased, it is irretrievable. Check carefully before proceeding.

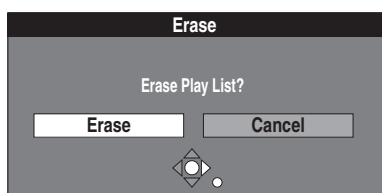

- Even if you erase the play list, the original title is not erased.

▶ Properties

Play list information (e.g., time and date) is shown.

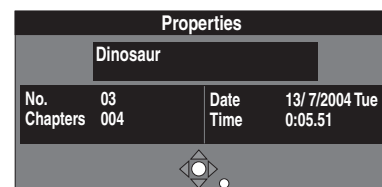

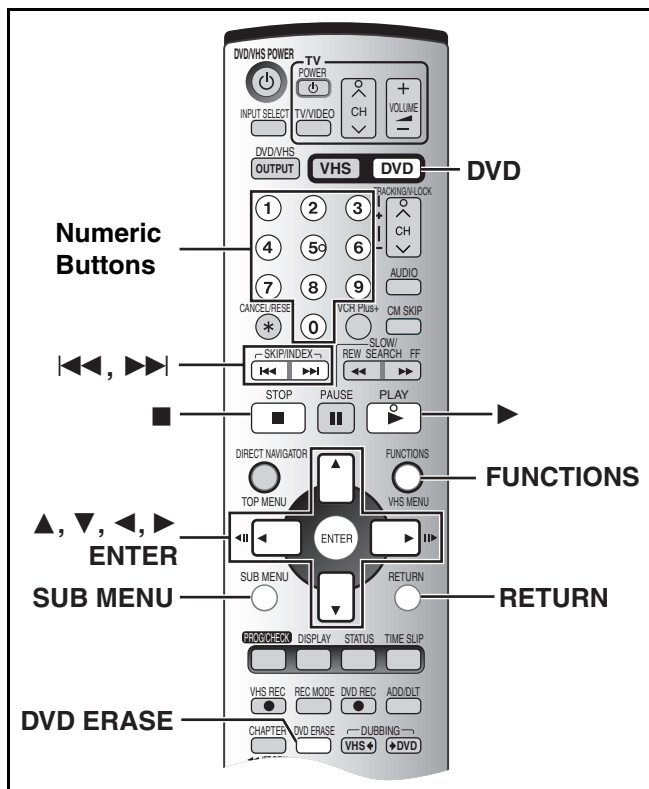

RAM

Preparation

- Create play lists first (→ 36).
- Release protection (disc → 30, cartridge → 18).
- Press [DVD].

For your reference

- You can use fast-forward, rewind, pause, and slow-motion while playing chapters just as you can during normal play.

- 1 Press [FUNCTIONS]. (→ 47)
- 2 Select "PLAY LIST" with [▲, ▼, ◀, ▶] and press [ENTER].
 - Chapters are not displayed if you have not yet created a play list with the disc.
- 3 Press [▲, ▼, ◀, ▶] to select the play list.
 - "To show other pages", → 37
 - "Multiple editing", → 37
- 4 Press [SUB MENU], then [▲, ▼] to select the operation and press [ENTER].

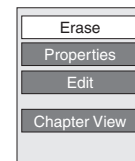

■ To clear the play list screen

Press [RETURN].

■ To stop partway

Press [RETURN].

▶ Edit

Edit Sub menu displayed.

- 5 Use [▲, ▼] to select the desired item and press [ENTER].

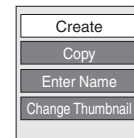

▶▶ Create

Refer to "Creating play lists". (→ 36)

▶▶ Copy

(Multiple editing is possible.)

- 6 Select "Copy" with [◀] and press [ENTER].

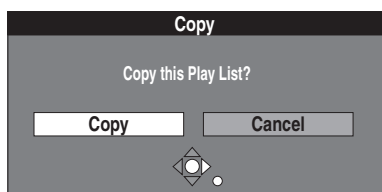

▶▶ Enter Name

Refer to "Entering text". (→ 32)

For your reference

- The full name is shown in the "Properties" screen, but if you enter a long name, only part of it is shown in the play list screen.

▶▶ Change Thumbnail

You can change the image to be shown as a thumbnail picture in the Play List View.

- 6 Press [▶, PLAY] to play.

- 7 Press [ENTER] at the point you want to display. (→ 35, "For quicker editing")

- To change to another point in the same title:
 - Select "Change" with [▲, ▼] and press [▶, PLAY], and then repeat steps 7–8.

- 8 Select "Exit" with [▲, ▼] and press [ENTER].

- The displayed scene is changed at this point.

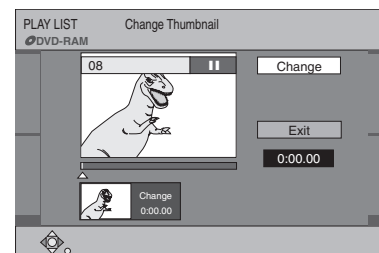

For your reference

- You cannot select the top and end of the title.

▶ Chapter View

5 Use [▲, ▼, ◀, ▶] to select a desired chapter.

- You can also select a chapter from the chapter view by entering a 3-digit number with the numeric buttons.
e.g.: "5": [0]→[0]→[5]
"15": [0]→[1]→[5]
- If you enter a number larger than the total number of chapters, the last chapter is selected.
- To edit → Follow the steps below.
- Editing chapters in a play list does not modify the source titles and source chapters.

6 Press [SUB MENU]

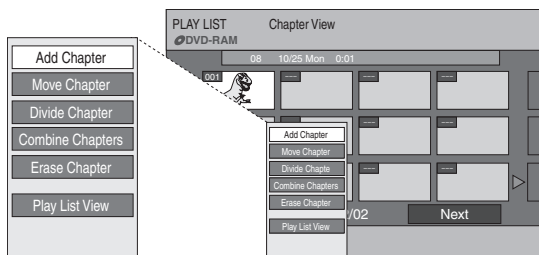

7 Use [▲, ▼] to select a desired item and press [ENTER].

To show other pages

Press [▲, ▼, ◀, ▶] to select "Previous" or "Next" and press [ENTER].

- You can also press [◀◀, SKIP] or [▶▶, SKIP] to show other pages.

To play a chapter

Press [ENTER] after step 5.

To stop chapter play

Press [■, STOP]. (The chapter view appears.)

To erase a chapter during play

- Press [DVD ERASE].
 - A confirmation message will be displayed.
- Use [◀] to select "Erase" and press [ENTER].

▶▶ Add Chapter

Refer to "Creating play lists", step 4–7. (→ 36)

▶▶ Move Chapter

8 Use [▲, ▼, ◀, ▶] to select the position to insert the chapter and press [ENTER].

- The chapter is moved and inserted before the highlighted chapter.

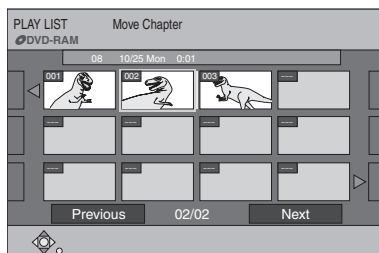

▶▶ Divide Chapter

8 Press [ENTER] at the point you want to divide.

- (→ 35, "For quicker editing")
- Repeat this step to divide at other points.

9 Select "Exit" with [▼] and press [ENTER].

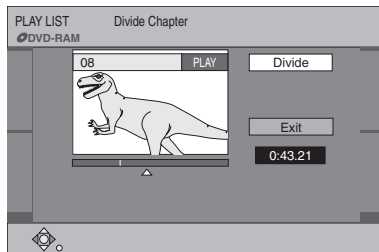

Note

- A little portion of the recording directly preceding the division point may be lost.

For your reference

- The divided titles retain the name of the original title. They also retain the CPRM property (→ 18) of the original.
- It is not possible to carry out "Divide", when the resulting part(s) are extremely short.

▶▶ Combine Chapters

8 Select "Combine" with [◀] and press [ENTER].

- The selected chapter and next chapter are combined.

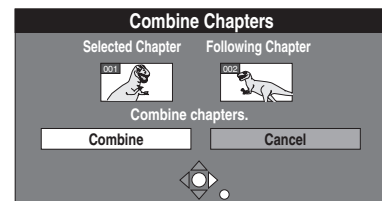

▶▶ Erase Chapter

(Multiple editing is possible.)

8 Select "Erase" with [◀] and press [ENTER].

- Even if you erase the chapter, the original title is not erased.

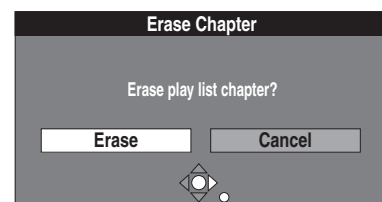

▶▶ Play List View

Go back to Play List View.

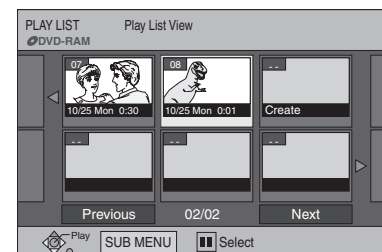

Using DISPLAY menus

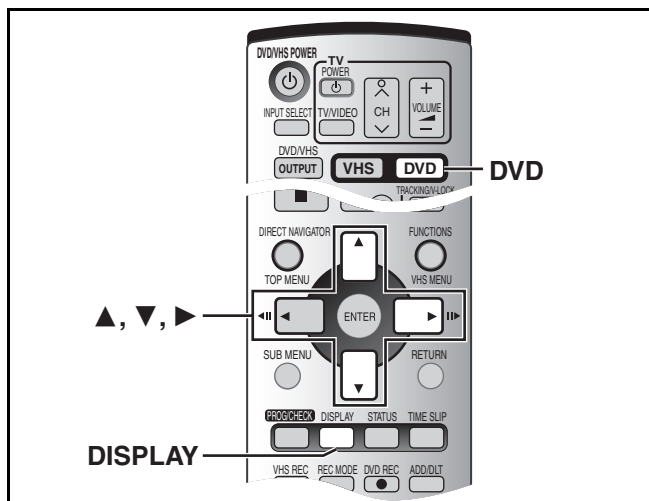

RAM DVD-R DVD-A DVD-V CD VCD MP3

Remote control only

DISPLAY menus contain information about the disc or unit. These menus allow you to perform the following operations:

- You can change the subtitles and the angle when using DVD-Video.
- You can enjoy repeat play.
- You can change picture and sound settings when playing back a DVD.

▶ Disc menu

RAM DVD-R DVD-A DVD-V VCD

Disc	Sound track	1	DD Digital 2/0ch
Play	Subtitle	OFF	
Video	Audio channel	LR	

Sound track

Sound track language **DVD-A DVD-V**

(See [A] Sound track/Subtitle language)
Change the number to select a sound track.

Audio attribute **RAM DVD-R DVD-A DVD-V**

(See [B] Audio attributes)

Karaoke vocals, on and off (Karaoke **DVD-V** only)

Solo: ON ↔ OFF
Duet: OFF ↔ V1 + V2 ↔ V1 ↔ V2 ↔ OFF...

Subtitle

Subtitle language **DVD-A DVD-V**

(See [A] Sound track/Subtitle language)
Change the number to select a subtitle language.

Subtitles ON/OFF **RAM DVD-R DVD-A DVD-V**

Turn the subtitles ON or OFF.

Angle **DVD-A DVD-V**

Change the number to select an angle.

STILL-P **DVD-A**

Page

Still picture number

- When "Return" is displayed, select it and press [ENTER] to return to the default page.
- When "RANDOM" is displayed, select it and press [ENTER]. The picture changes randomly each time you press [ENTER].

Slide show (Display only)

Audio channel **RAM VCD**

Select the audio channel. (→ 23)

PBC **VCD** (→ 63)

Playback control on/off

Indicates whether menu play (playback control) is on or off.

■ Common procedures

Preparation

- Press [DVD].

1 Press [DISPLAY].

Disc	Sound track	1	DD Digital 2/0ch
Play	Subtitle	OFF	
Video	Audio channel	LR	

Menu Item Setting

2 Select the menu with [▲, ▼] and press [▶].

3 Select the item with [▲, ▼] and press [▶].

4 Select the setting with [▲, ▼].

- Some options require different operations. Follow the on-screen instructions and the instructions described later.

■ When you are finished

Press [DISPLAY].

For your reference

- The screens depend on the disc contents.
- Depending on the condition of the unit (playing, stopped, etc.) and the type of software you are playing, there are some items that you cannot select or change.

[A] Sound track/Subtitle language

ENG: English	SVE: Swedish	CHI: Chinese
FRA: French	NOR: Norwegian	KOR: Korean
DEU: German	DAN: Danish	MAL: Malay
ITA: Italian	POR: Portuguese	VIE: Vietnamese
ESP: Spanish	RUS: Russian	THA: Thai
NLD: Dutch	JPN: Japanese	*: Others

[B] Audio attributes

LPCM/PPCM/DD Digital/DTS/MPEG: Signal type

k (kHz): Sampling frequency

b (bit): Number of bits

ch (channel): Number of channels

For your reference

- When playing back recordings of bilingual broadcasts, "1 + 1 ch" will be displayed.
- You can only select subtitles, sound tracks, and angles if they are recorded on the disc.
- Some discs allow changes to sound tracks, subtitles, and angles only by using the disc's menus.
- If the subtitles overlap closed captions recorded on discs, turn the subtitles off.

▶ Play menu

RAM DVD-R DVD-A DVD-V CD VCD MP3

Disc	Repeat Play	OFF
Play		
Video		
Audio		

Repeat play

This function works only when the elapsed play time is displayed.

RAM DVD-R DVD-V

Title↔Chapter↔OFF
↑↔↓

CD VCD

Track↔All↔OFF
↑↔↓

DVD-A MP3

Track↔Group↔OFF
↑↔↓

While playing a play list

RAM

PL (play list)↔OFF
↑↔↓

Note

- Repeat play may not work as desired with some discs.
- You cannot use repeat play for an entire DVD-Audio, DVD-Video, MP3 discs or all the play lists on a DVD-RAM.
- While playing back, you can set repeat play. When stopped, the repeat play operation is cancelled.
- [DUBBING] or [DVD ERASE] does not work while in repeat play

▶ Video menu

RAM DVD-R DVD-A DVD-V VCD

Disc	Picture	Normal
Play	MPEG-DNR	ON
Video	Progressive	ON
Audio	Transfer	Auto 1

Picture

To select the picture mode during play

Normal: Default setting

Soft: Soft picture with fewer video artifacts

Fine: Details are sharper

Cinema: Mellow movies, enhances detail in dark scenes.

MPEG-DNR

Reduces noise and picture degradation.

You can turn the recommended settings for DNR on and off.

ON↔OFF

*Progressive (→ 63)

Select "ON" to enable progressive output.

• Select "OFF" if the picture is stretched horizontally.

• When progressive output is on, closed captions cannot be displayed.

ON↔OFF

*Transfer (When "Progressive" is set to "ON")

Select the method of conversion for progressive output to suit the type of material being played (→ 63, Film and video).

Auto1 (normal):

Detects 24 frame-per-second film content and appropriately converts it.

Auto2: Compatible with 30 frame-per-second film content in addition to 24 frame-per-second film content.

Video: Select when using Auto1 and Auto2, and the video content is distorted.

* Only when you have selected "480P" in "TV Type" (→ 17).

▶ Audio menu

RAM DVD-R DVD-A DVD-V

Disc	V.S.S.	OFF
Play	Dialog Enhancer	OFF
Video		
Audio		

V.S.S.

RAM DVD-R DVD-V

(Only for Dolby Digital with 2 or more channels)

Enjoy a surround-like effect if you are using 2 front speakers only. The effect is broadened and sound seems to come from virtual speakers on either side if the disc has surround signals recorded on it.

Natural↔Emphasis↔OFF↔Natural...

Note

- V.S.S. will not work, or will have less effect, with some discs, even if you select "Natural" or "Emphasis".
- Turn V.S.S. off if it causes distortion.
- V.S.S. does not work for SAP recordings.

Dialog Enhancer

DVD-A DVD-V

(Dolby Digital, 3-channel or over only, including a center channel)

The volume of the center channel is raised to make dialog easier to hear.

ON↔OFF

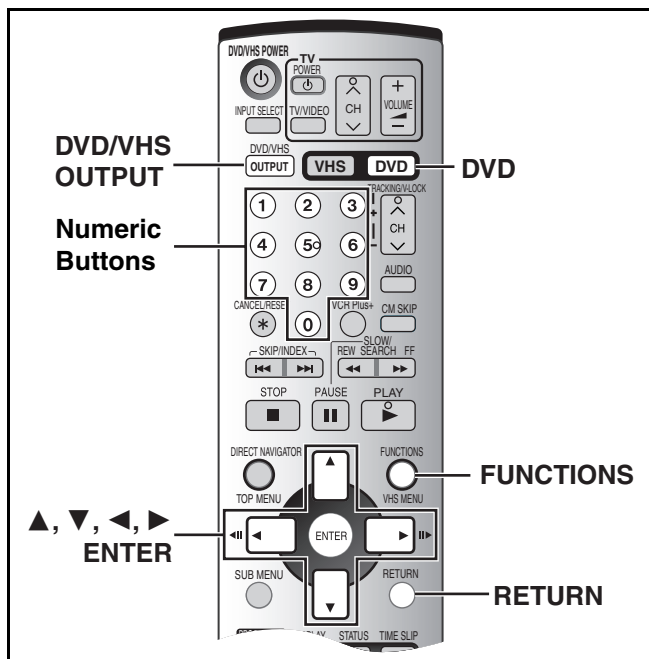

Changing the unit's settings

Preparation

- Press [DVD].

Common procedures

Use the following procedure to change the settings if necessary.

- 1 While stopped
Press [FUNCTIONS]. (→ 47)
- 2 Select "SETUP" with [▲, ▼, ◀, ▶] and press [ENTER].

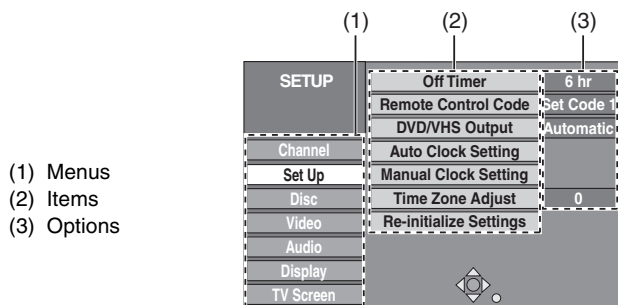

- (1) Menus
- (2) Items
- (3) Options

- 3 Use [▲, ▼] to select the menu's tab and press [◀, ▶].
- 4 Use [▲, ▼] to select the item to be changed and press [ENTER].
- 5 Use [▲, ▼] to select an option and press [ENTER].
 - Some options require different operations. Follow the displayed instructions.

To return to the previous screen

Press [RETURN]. Even if you have changed an option, the change is not activated until you press [ENTER].

To exit the screen

Press [RETURN] several times.

For your reference

- The settings remain intact even if you switch the unit to standby.

Entering a password (Ratings)

You can limit play of DVDs unsuitable for some audiences (children, for example). Play and changes to the settings are not possible unless you enter a password. (→ 43)

Preparation

- Press [DVD].

When setting ratings

The password screen is shown when you select levels 0 to 7.

- 1 Input a 4-digit password with the numeric buttons.
 - If you enter a wrong number, press [◀] to erase it before you press [ENTER].
 - Do not forget your password.
- 2 Press [ENTER].
- 3 Press [ENTER].

The password is entered and the unit is locked.

Now, when you insert a DVD-Video that exceeds the ratings limit you set, a message appears on the TV.

Follow the on-screen instructions.

When changing ratings

The password screen is shown when you select "Ratings".

- 1 Input a 4-digit password with the numeric buttons and press [ENTER].

- Unlock Recorder:** To unlock the unit and return the rating to 8
 - Change Password:** To change your password
 - Change Level:** To change the rating level
 - Temporary Unlock:** To temporarily unlock the unit (the unit locks again if you switch it to standby or open the disc tray)
- 2 Select the item with [▲, ▼] and press [ENTER].
Actual screens depend on the operation. Follow the on-screen instructions.

Summary of settings

This description shows the initial settings for this unit. For details on menu operation (→ 42).

- Underlined items are the factory presets.

■ Channel

Antenna System (→ 14)

[TV] [CATV]

Auto Channel Setting (→ 14)

Preset Channel Captions (→ 16)

Manual Channel Captions (→ 16)

VCR Plus+ CH Setting (→ 15)

■ Set Up

Off Timer

Select how long the unit remains on when it is not being used.

[2 hr] [6 hr] [Off]

Remote Control Code (→ 17)

[Set Code 1] [Set Code 2] [Set Code 3]

DVD / VHS Output (→ 12)

Select how to switch the output from the DVD/VHS COMMON output terminal on the back of this unit.

[Automatic] [Manual]

Automatic	Select this when you want to switch the output automatically according to the operation or action of this unit. <ul style="list-style-type: none"> • You can also switch the output by pressing [DVD/VHS OUTPUT].
Manual	Select this when you want to switch the output between DVD and VHS manually. <ul style="list-style-type: none"> • The output is switched alternately by pressing [DVD/VHS OUTPUT].

Auto Clock Setting (→ 46)

Manual Clock Setting (→ 46)

Time Zone Adjust (→ 46)

This corrects the time set in Auto Clock Setting.

The status is not displayed on the Set Up menu when the Auto Clock Setting is not set.

[-1] [0] [+1]

Re-initialize Settings

This returns all values in the SETUP menus, except for the clock, channel settings, ratings level, and on-screen language, to the default settings.

[Yes] [No]

■ Disc

Languages

Choose the language for audio, subtitle and disc menus. **DVD-V** Press [ENTER] to display the menu.

- Some discs are designed to start in a certain language despite any changes made here.
- If a language which is not recorded is selected, or if languages are already fixed on the disc, the language set as the default on the disc will be played instead.

Audio Language

[English] [French] [Spanish] [Original] [Other *****]

Subtitle Language

[Automatic] [English] [French] [Spanish] [Other *****]

Menu Language

[English] [French] [Spanish] [Other *****]

Original

The original language of each disc will be selected.

Other *****

This is the language code setting.

Input a code number with the numeric buttons. (→ 45, "Language code list".)

Automatic

If the language selected for "Audio Language" is not available, subtitles of that language will automatically appear if available on that disc.

Ratings (→ 42)

Set a ratings level to limit DVD-Video play.

Setting ratings (When level 8 is selected)

[8 No Limit]: All DVD-Video can be played.

[1] to [7]: Prohibits play of DVD-Video with corresponding ratings recorded on them.

[0 Lock All]: Prohibits play of all DVD-Video.

Changing ratings (When level 0-7 is selected)

[Unlock Recorder] [Change Password]

[Change Level] [Temporary Unlock]

Recording Time in EP Mode

Select the maximum number of hours for recording in EP mode (→ 27, "Recording modes and approximate recording times").

[EP (6H)] [EP (8H)]

EP (6H)	You can record for 6 hours on an unused 4.7 GB disc.
EP (8H)	You can record for 8 hours on an unused 4.7 GB disc.

Play DVD-Audio in Video Mode

Select "Video (On)" to play DVD-Video content on DVD-Audio.

[Video (On)] [Audio (Off)]

Video (On)	The setting returns to "Audio (Off)" when you change the disc or turn the unit off.
-------------------	---

Underlined items are the factory presets.

■ Video

3-D Y/C Separation

[On] [Off]

On	Reduces noise by separating the luminance (Y) and color (C) signals when recording.
Off	Reduces the ghosting that occurs when recording fast moving images.

Hybrid VBR Resolution (→ 63, "VBR") **RAM**

[Automatic] [Fixed]

Automatic	The resolution is automated to provide efficient recording with less block-shaped noise.
Fixed	The resolution is fixed to ensure there is no loss of source picture resolution while recording.

Still Mode

Select the type of picture shown when you pause play.

(→ 63, "Frame and field")

[Automatic] [Field] [Frame]

Field	Select if jittering occurs when "Automatic" is selected.
Frame	Select if small text or fine patterns cannot be seen clearly when "Automatic" is selected.

Line-in NR

Reduces video tape noise while transferring (dubbing).

• When noise reduction is on, "3-D Y/C Separation" (→ above) does not work regardless of the setting.

[Automatic] [On] [Off]

Automatic	Noise reduction only works on picture input from a video tape.
On	Noise reduction works for any video input.
Off	Noise reduction is off. Select when you want to record input as is.

Black Level Control

Select normal, lighter or darker for adjusting the black level control to the desired setting for picture enhancement.

Input Level

Adjusts the black level of the input signal.

[Lighter] [Darker]

Output Level (Composite/S Video)

Adjusts the black level of the output signal from the VIDEO OUT and S-VIDEO OUT terminal.

[Lighter] [Darker]

Output Level (Component)

Adjusts the black level of the output signal from the COMPONENT VIDEO OUT (Y/Pb/Pr) terminals.

[Lighter] [Normal] [Darker]

■ Audio

Search Audio & PLAY ×1.3

RAM **DVD-R** **DVD-A** **DVD-V** **VCD** (→ 21)

Choose whether to operate the Quick View (Play ×1.3) or not and whether to have sound during search.

[On] [Off]

DVD-A

• You may hear sound regardless of this setting with some discs.

D. Range Compression

DVD-V (Dolby Digital only)

Change the dynamic range for late night viewing.

[On] [Off]

Select MTS

Select whether to record the main or secondary audio type (SAP) when recording or transferring (dubbing) to DVD-R. (You cannot change secondary audio when recording audio to DVD-R from an external source.)

• When recording/transferring (dubbing) to DVD-R

[Main] [SAP]

Digital Audio Output

Change the settings when you have connected equipment through this unit's DIGITAL AUDIO OUT terminal (→ 12).

Press [ENTER] to display the menu.

PCM Down Conversion

Select how to output audio with a sampling frequency of 96 kHz or 88.2 kHz.

• Signals are converted to 48 kHz or 44.1 kHz despite the above settings if the signals have a sampling frequency of over 96 kHz or 88.2 kHz, or the disc has copy protection.

[On] [Off]

On	Signals are converted to 48 kHz or 44.1 kHz. (Choose when the connected equipment cannot process signals with sampling frequency of 96 kHz or 88.2 kHz.)
Off	Signals are output as 96 kHz or 88.2 kHz. (Choose when the connected equipment can process signals with sampling frequency of 96 kHz or 88.2 kHz.)

Dolby Digital

Choose whether to output Dolby Digital bitstream signals for decoding on other equipment or to convert them to PCM signals for 2-channel output.

[Bitstream] [PCM]

Bitstream	When you have connected a unit with a built-in Dolby Digital decoder.
PCM	When you have connected a unit that doesn't have a built-in Dolby Digital decoder.*

DTS

Choose whether to output DTS bitstream signals for decoding on other equipment or to not.

[Bitstream] [PCM]

Bitstream	When you have connected a unit with a built-in DTS decoder.
PCM	When you have connected a unit that doesn't have a built-in DTS decoder.*

* Set "Dolby Digital" to "PCM" and "DTS" to "PCM" if the other equipment doesn't have decoders. Incorrect settings can cause noise to be output which can be harmful to your ears and speakers, and audio will not be recorded properly to digital recording equipment.

Various Settings



Underlined items are the factory presets.

■ Display

Status Messages

Choose whether to show status messages automatically or not.

[Automatic] [Off]

On-screen Language

Choose the language for these menus and the on-screen messages.

[English] [Español] [Français]

Blue Background

Select whether to show the blue background, normally shown when TV reception is poor.

[On] [Off]

Front Display

Changes the brightness of the unit's display.

[Bright] [Dim] [Automatic]

Automatic	The display turns dark during play, and reappears momentarily if a button is pressed. When the unit is turned off all displays disappear. While using this mode the standby power consumption can be reduced.
------------------	---

■ TV Screen

TV Type (→ 17)

Choose the setting to suit your TV and preference.

[Aspect 4:3 & 480I] [Aspect 4:3 & 480P]
[Aspect 16:9 & 480I] [Aspect 16:9 & 480P]

4:3 TV Settings for DVD-Video

You can select how to display the image on the TV when you watch 16:9 images (DVD-Video) on a 4:3 standard aspect TV.

[Pan & Scan] [Letterbox]

Pan & Scan	Video recorded for a widescreen is played with the sides cut off if Pan & Scan was specified by the producer of the disc. If 16:9 software prohibits Pan & Scan, the image will appear in the letterbox style (with black bands above and below the picture) despite the setting here.
Letterbox	Video recorded for a widescreen is played in the letterbox style.

4:3 TV Settings for DVD-RAM

You can select how to display the image on the TV when you watch 16:9 images (DVD-RAM) on a 4:3 standard aspect TV.

[4:3] [Pan & Scan] [Letterbox]

4:3	Titles played as recorded.
Pan & Scan	Video recorded for a widescreen is played with the sides cut off if the Pan & Scan format is specified at the time of recording.
Letterbox	Video recorded for a widescreen is played in the letterbox style.

Language code list

Abkhazian: 6566	Chinese: 9072	Hausa: 7265	Lithuanian: 7684	Romanian: 8279	Telugu: 8469
Afar: 6565	Corsican: 6779	Hebrew: 7387	Macedonian: 7775	Russian: 8285	Thai: 8472
Afrikaans: 6570	Croatian: 7282	Hindi: 7273	Malagasy: 7771	Samoan: 8377	Tibetan: 6679
Albanian: 8381	Czech: 6783	Hungarian: 7285	Malay: 7783	Sanskrit: 8365	Tigrinya: 8473
Ameharic: 6577	Danish: 6865	Icelandic: 7383	Malayalam: 7776	Scots Gaelic: 7168	Tonga: 8479
Arabic: 6582	Dutch: 7876	Indonesian: 7378	Maltese: 7784	Serbian: 8382	Turkish: 8482
Armenian: 7289	English: 6978	Interlingua: 7365	Maori: 7773	Serbo-Croatian: 8372	Turkmen: 8475
Assamese: 6583	Esperanto: 6979	Irish: 7165	Marathi: 7782	Shona: 8378	Twi: 8487
Aymara: 6588	Estonian: 6984	Italian: 7384	Moldavian: 7779	Sindhi: 8368	Ukrainian: 8575
Azerbaijani: 6590	Faroese: 7079	Japanese: 7465	Mongolian: 7778	Singhalese: 8373	Urdu: 8582
Bashkir: 6665	Fiji: 7074	Javanese: 7487	Nauru: 7865	Slovak: 8375	Uzbek: 8590
Basque: 6985	Finnish: 7073	Kannada: 7578	Nepali: 7869	Slovenian: 8376	Vietnamese: 8673
Bengali, Bangla: 6678	French: 7082	Kashmiri: 7583	Norwegian: 7879	Somali: 8379	Volapük: 8679
Bhutani: 6890	Frisian: 7089	Kazakh: 7575	Oriya: 7982	Spanish: 6983	Welsh: 6789
Bihari: 6672	Galician: 7176	Kirghiz: 7589	Pashto, Pushto: 8083	Sundanese: 8385	Wolof: 8779
Breton: 6682	Georgian: 7565	Korean: 7579	Persian: 7065	Swahili: 8387	Xhosa: 8872
Bulgarian: 6671	German: 6869	Kurdish: 7585	Polish: 8076	Swedish: 8386	Yiddish: 7473
Burmese: 7789	Greek: 6976	Laotian: 7679	Portuguese: 8084	Tagalog: 8476	Yoruba: 8979
Byelorussian: 6669	Greenlandic: 7576	Latin: 7665	Punjabi: 8065	Tajik: 8471	Zulu: 9085
Cambodian: 7577	Guarani: 7178	Latvian, Lettish: 7686	Quechua: 8185	Tamil: 8465	
Catalan: 6765	Gujarati: 7185	Lingala: 7678	Rhaeto-Romance: 8277	Tatar: 8484	

Clock Settings

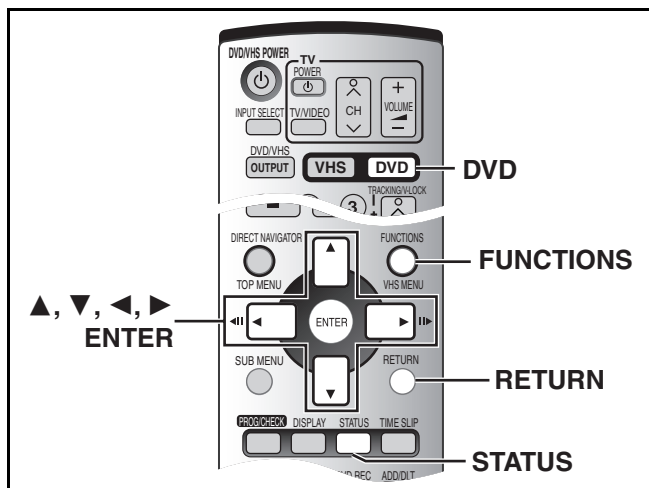

Preparation

- Press [DVD].
- 1 While stopped**
Press [FUNCTIONS]. (→ 47)
 - 2** Select "SETUP" with [▲, ▼, ◀, ▶] and press [ENTER].
 - 3** Select "Set Up" tab with [▲, ▼] and press [◀, ▶].

SETUP	Off Timer	6 hr
	Remote Control Code	Set Code 1
	DVD/VHS Output	Automatic
Channel	Auto Clock Setting	
Set Up	Manual Clock Setting	
Disc	Time Zone Adjust	0
Video	Re-initialize Settings	
Audio		
Display		
TV Screen		

▶ Auto Clock Setting

- 4** Select "Auto Clock Setting" with [▲, ▼] and press [ENTER].
- 5** Press [ENTER].

Auto setting starts. This can take some time, up to a few hours in some cases. The following screen appears when setting is complete.

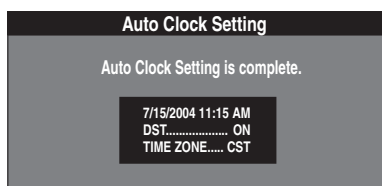

- If the time was not set correctly, use manual clock setting or time zone adjust.
- DST, Daylight Saving Time, shows the summertime setting.
- TIME ZONE shows the time difference from Greenwich mean time (GMT).
 - EST (Eastern Standard Time) = GMT -5
 - CST (Central Standard Time) = GMT -6
 - MST (Mountain Standard Time) = GMT -7
 - PST (Pacific Standard Time) = GMT -8
 - AST (Alaska Standard Time) = GMT -9
 - HST (Hawaii Standard Time) = GMT -10
 - For other areas: xx hr

- 6** Press [ENTER].

■ To cancel partway

Press [RETURN].

▶ Time Zone Adjust

Adjust the time zone (-1 or +1) if it was not set correctly with auto clock setting.

You cannot change this setting if you set the clock manually.

- 4** Select "Time Zone Adjust" with [▲, ▼] and press [ENTER].

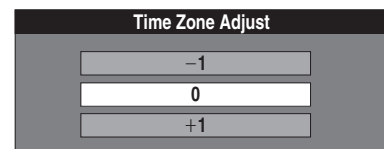

- 5** Select "-1" or "+1" with [▲, ▼] and press [ENTER].

▶ Manual Clock Setting

- 4** Select "Manual Clock Setting" with [▲, ▼] and press [ENTER].

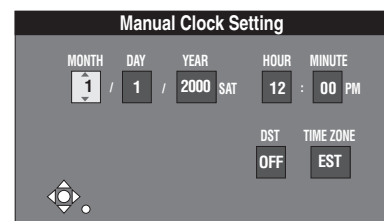

- 5** Use [◀, ▶] to select the item you want to change and press [▲, ▼] to change the setting.

- DST (Daylight Saving Time): ON or OFF

If you select "ON", the clock is advanced one hour starting at 2 a.m. on the first Sunday in April and ending at 2 a.m. on the last Sunday in October.

- TIME ZONE (→ above)

- 6** Press [ENTER].

- The clock starts.

• When you change the time zone, the recording times for titles recorded before the time zone was changed also change to correspond to the new time zone.

■ To return to the previous screen

Press [RETURN].

FUNCTIONS window

By using the FUNCTIONS window you can access the main functions quickly and easily.

Preparation

- Press [DVD].

1 While stopped

Press [FUNCTIONS].

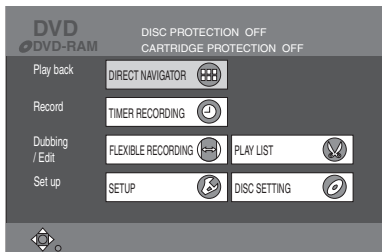

- Functions displayed depend on the type of disc.

2 Press [▲, ▼, ◀, ▶] to select an item and press [ENTER].

■ To exit the FUNCTIONS window

Press [FUNCTIONS].

Status displays

Preparation

- Press [DVD].

■ Changing the information displayed

Status messages appear on the TV when operating the unit to show you what operation was performed and what condition the unit is in.

Press [STATUS] to change the information displayed.

The display changes each time you press the button.

For example, DVD-RAM

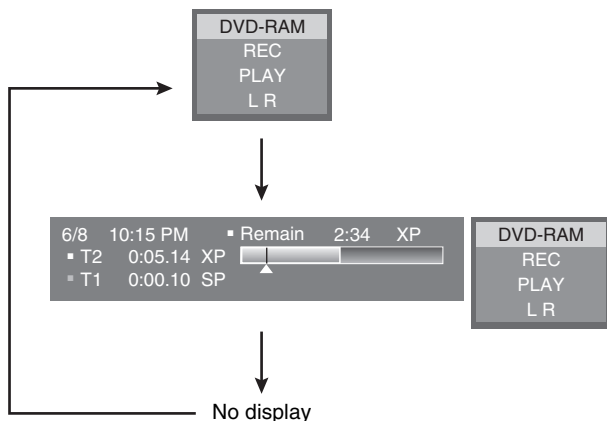

■ Display examples

- (1) Current medium
- (2) Current recording or play status, input channel
 - Shows the current state of the unit and the input channel.
 - REC: Recording
 - PAUSE: Recording paused
 - PLAY: Playing
 - PLAY × 1.3: Quick Viewing (Play × 1.3)
 - II: Playing Paused
 - ▶▶: Fast forwarding (5 speeds)
 - ◀◀: Rewinding (5 speeds)
 - I◀: Slow-motion (5 speeds)
 - ◀I: Reverse slow-motion (5 speeds)
 - OPEN/CLOSE: Indicates the status of the disc tray

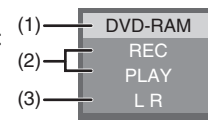

(3) Audio type (→ 23, 27)

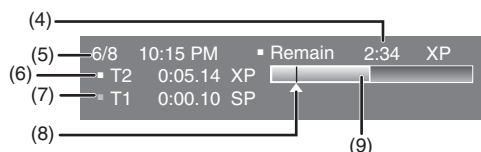

- (4) Available recording time and recording mode (e.g.: "2:34 XP" indicates 2 hours and 34 minutes in XP mode)
- (5) The current date and time
- (6) Recording time
 - Shows recording time, recording mode and a rough guide to how much space has been used for recording on the disc.
- (7) Elapsed play time
- (8) Play position
- (9) Amount of recording space used

Inserting video cassette

The surface from which you can see a roll of tape should face up,
Insert a video cassette.

- This unit is automatically turned on.

■ To eject a video cassette

- You can eject a video cassette when the unit is in standby mode. It switches back to standby once it ejects the video cassette.

For main unit.

- Press [**▲**, EJECT] on the main unit.

For remote control.

- Press [VHS] and then press and hold [**■**, STOP] for about 3 or more seconds.



Video cassette information

■ Video cassettes

- Break out the video cassette's tab to prevent accidental erasure. Cover the hole with a double layer of adhesive tape when you want to use the video cassette for recording again.
- You can use video cassettes with the VHS and S-VHS marks, but this unit is unable to make full use of the characteristics of S-VHS video cassettes.

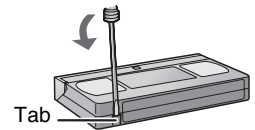

■ Video cassette care

- Poor quality or damaged video cassettes can cause the heads to become dirty and malfunction. Store your video cassettes carefully and discard them when they become dirty or damaged.
- Never use video cassettes on which juice has been spilt or those that are extremely damaged since this will not only cause the heads to become dirty, but will also make the unit malfunction.

■ Maintenance

Cleaning the video heads

Dirt on the video heads can cause poor recording and play.



If the picture does not improve, use an optional head-cleaning cassette (part number NV-TCL30PT). If the problem persists, seek advice from a qualified service person.

Cautions before you operate this unit

Avoid:

- Magnets or electromagnetic objects.
- Putting anything heavy on the unit.

Do:

- Install the unit in a horizontal position.

Condensation may form in the following cases:

- The unit is brought from cold surroundings into a well-heated room.
- The unit is suddenly brought from cool surroundings, such as an air-conditioned room or car, to a place which is hot and humid.

Note:

- In any of the above-mentioned conditions, do not operate the unit for at least 1 hour. This unit is not equipped with a dew sensor.

Playing a video cassette

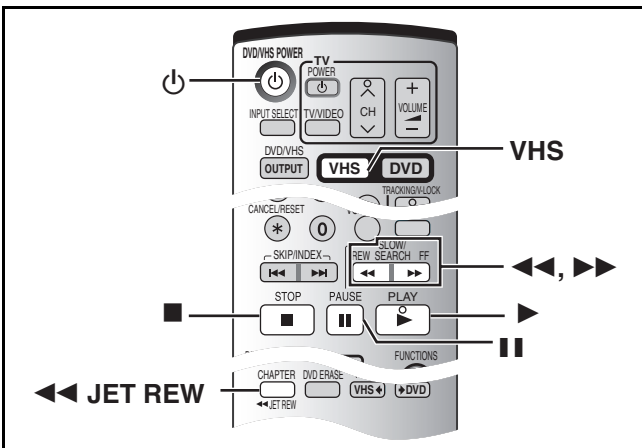

Preparation

- Select the unit viewing channel (or the AV input) on the TV.
- Press [VHS].

- 1 Press [⏻, DVD/VHS POWER] to turn the unit on.
- 2 Insert a recorded video cassette. (→ 48)
- 3 Press [▶, PLAY].
 - Play starts automatically if you insert a video cassette that has had its tab removed.

Preparation

- Press [VHS].

Fast-forward / Rewind

While stopped

Press [◀◀] (backward)/[▶▶] (forward).

Cue / Review

During play

Tap or keep pressing [◀◀] (backward)/[▶▶] (forward).

- If you keep pressing these buttons, playback restarts by releasing them.
- Press [▶, PLAY] to restart playback.

Jet Search

During play

Tap [◀◀] (backward)/[▶▶] (forward) twice. You can increase Cue/Review search speed.

- Press [▶, PLAY] to restart playback.
- Select search speed to view the recorded picture. (→ 56)
- The picture that appears in EP or VP mode at approx. 35 times speed may be distorted. A vertical scroll may occur. It is not a malfunction but if it happens, change to approx. 27 times speed.
- The picture may not be in colour or may be distorted depending on the TV.

■ To still playback

Press [⏸, PAUSE]. (Press again to restart play.)

■ To stop play

Press [■, STOP].

Note:

- When the unit is off, an inserted video cassette can be played back by pressing [▶, PLAY].
- When the tape reaches its end, this unit automatically rewinds it to the beginning. This function does not work during timer recording, fast-forwarding and specified stop recording.
- Jet Search, cue, review or slow playback will be automatically released after 10 minutes, and still playback, after 5 minutes.
- When viewing a still picture or slow playback, the picture that appears in VP mode may be distorted.
- When playing back a tape which was recorded on another VCR, it may be necessary to adjust tracking (→ 50). In some cases the picture quality may still be inferior. This is due to format constraints.

Slow

During play

Press and hold [⏸, PAUSE] for 2 seconds or more.

- Press [▶, PLAY] to restart playback.

Jet Rewind

To perform a Higher Speed Rewind

Press [JET REW ◀◀].

The "J. REW" indication appears on the TV screen (except when the remaining tape time indication appears).

- Depending on the tape or an operating condition, the rewind speed may change somewhat.
- The tape counter is reset to "0:00.00" when the tape is rewound to the beginning.
- Depending on the tape, this function may not work.

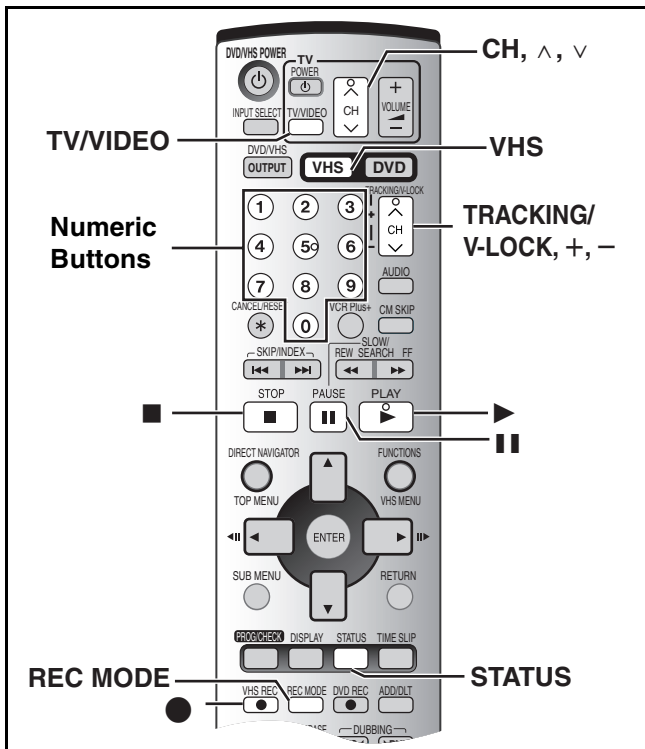

Preparation

- Press [VHS].

S-VHS Quasi Playback (SQPB)

- It is also possible to play back tapes recorded in the S-VHS system.
- Some picture noise may occur depending on the type of tape used.
 - It is not possible to fully obtain the high resolution that S-VHS is capable of.
- It is not possible to record in the S-VHS system with this unit.

Repeat Playback

During play or while stopped

Keep pressing [▶, PLAY] for 5 or more seconds.

- The "RP" indication appears on the display.
- At the end of the program, the tape rewinds to the beginning of the program and plays it again (it only works if there is at least 5 seconds blank at the end of the program). This repeats until you cancel it.

To cancel

Press [■, STOP].



Adjusting the playback picture

Manual tracking

The unit usually makes tracking adjustments, but you may need to do it manually if noise appears on a tape recorded on other equipment.

During play

Press [TRACKING/V-LOCK, +] or [TRACKING/V-LOCK, -].

Repeat until the noise disappears.

Vertical locking adjustment

Adjust the vertical to stop the picture from jiggling while paused.

While paused

Press [TRACKING/V-LOCK, +] or [TRACKING/V-LOCK, -].

Repeat until the jiggling stops.

To return to auto tracking

Press both [TRACKING/V-LOCK, +] and [TRACKING/V-LOCK, -] simultaneously.

To remove the noise from a paused picture

Start slow play, then adjust the tracking.

Note:

- This may not work with some TV models and tapes.
- You can also adjust the tracking and vertical with [CH, ^, v] on the unit.

Recording TV programs

Preparation

- Select the unit viewing channel (or the AV input) on the TV.
- Check that the clock is set to the correct time. If it has not been set, refer to page 46.
- Press [VHS].

1 Insert a video cassette with an intact erasure prevention tab. (→ 48)

2 Press [CH, ▲, ▼] to select the TV station.

- If you keep pressing these buttons, the channels change quickly.
- You can also select channels with the numeric buttons.

TV Mode (Airwaves)

e.g., "5": [0]→[5]
 "15": [1]→[5]

CATV Mode (Cable)

e.g., "5": [0]→[0]→[5]
 "15": [0]→[1]→[5]
 "115": [1]→[1]→[5]

3 Press [REC MODE] to select the tape speed.

Each time you press the button:
 SP→EP→VP→SP

4 Press [●, VHS REC] to start recording.

■ To pause Recording

Press [||, PAUSE]. (Press it again to restart recording.)

■ To stop recording

Press [■, STOP].

Tape speed

SP: You can record the length shown on the tape.

EP: Three times the length of SP mode.

VP: Five times the length of SP mode.

- To have a longer recording capacity, select "EP" or "VP".
- If the image quality is important to you or if you wish to store the tape for a long period, select "SP".
- This unit can play tapes recorded with LP mode on other equipment ("LP" lights on the display).

VP mode:

- "VP" flashes on the unit's display for 8 seconds after recording has started.
- **A tape recorded in VP mode by this unit cannot be played back by other VCRs. It is recommended to distinguish it from other tapes by indicating "VP" on the tape label, etc.**
- It takes more time for automatic tracking to work when playing tapes recorded with VP mode, and it may not work at all with some tapes. Do tracking manually if this is the case (→ 50).

Note:

- **Even if the video cassette you use is labeled "S-VHS", it is not possible to record in the S-VHS system with this unit. It records in normal VHS system.**
- **You cannot play VP recording on other equipment.**
- You cannot change channels while recording. You can change channels while in pause mode.
- When recording is paused for more than 5 minutes, the unit returns to stop mode.

■ To Display the Approximate Remaining Tape Time

1 Select "TAPE SELECT" from the on screen display and select the corresponding tape length. (→ 56)

2 Press [STATUS].

The display changes as follows each time [STATUS] is pressed.

Clock → Counter → **Remaining Tape Time** → Clock

- The remaining tape time may not be displayed correctly depending on the tape used.

■ To specify a time to stop recording

While recording

Press [●, VHS REC] to select the recording time.

- On the main unit, press [●, REC].

Unit's Display

Each time you press the button:

Counter (cancel) → 0:30 → 1:00 → 1:30

↑ 4:00 ← 3:00 ← 2:00 ←

For your reference

- This does not work during timer recording.
- Recording stops and the set time is cleared if you press [■, STOP].
- The set time is cleared if you change the recording mode or channel while recording is paused.

Watching the TV while recording

1 Press [TV/VIDEO] to change the input mode to "TV".

2 Press TV's [CH, ▲, ▼] to select the desired TV channel.

For your reference

- You can also do this if the unit is making a timer recording.
- The recording is unaffected.

Playing/Recording DVD while recording

You can watch play or record discs while recording. The recording will not be affected.

- DVD playback (→ 21)

- DVD recording (→ 26)

- When a tuner channel is being recorded on VHS, you can only record the same channel on DVD.

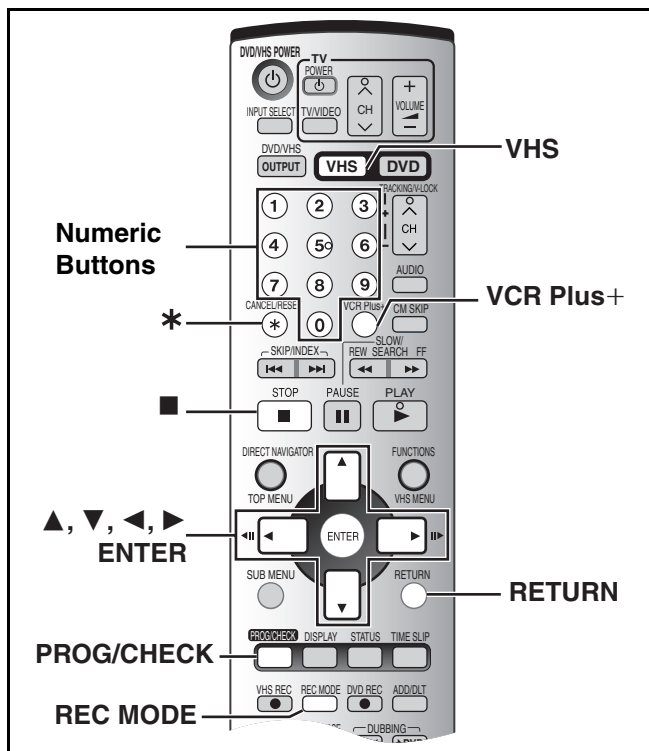

Caution for Timer recording

Timer recording automatically starts at the set time.
 • Timer recording can be started whether the unit is turned on or off. When the unit is turned off, the sound and the video cannot be outputted to the TV.

You can enter up to 16 programs up to a month in advance.

Preparation

- Select the unit viewing channel (or the AV input) on the TV.
- Check that the clock is set to the correct time. If it has not been set, refer to page 46.
- Insert a video cassette with an intact erasure prevention tab. (→ 48)
- Press [VHS].

Using VCR Plus+ system

Entering the PlusCode numbers is an easy way of timer recording. You can find these codes in TV listings in newspapers and magazines.

- When connecting a cable TV box or satellite receiver, the VCR Plus+ system does not work. Program the timer recording manually (→ right).

1 Press [VCR Plus+].

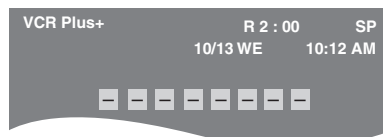

2 Press the numeric buttons to enter the PlusCode number.

- Press [◀] to move back to correct a digit.

3 Press [ENTER].

Confirm the program and correct it if necessary using [▲, ▼, ▶, ◀]. (→ right, step 3).



- "INVALID ENTRY" is displayed when you enter the wrong PlusCode number. Reenter the PlusCode number.

4 If the program is correct

Press [ENTER].

- "☺" lights on the unit's display.

5 Press [RETURN].

Manual programming

- When connecting a cable TV box or satellite receiver, select the channel on the cable TV box or satellite receiver before timer recording starts.

1 Press [PROG/CHECK].

- Make sure "NEW TIMER PROGRAM" is selected.

Highlighted line is ready for programming.

CH	DATE	ON	OFF	SP
25	13WE	10:12 AM	10:30 AM	S P
NEW TIMER PROGRAM				

2 Press [ENTER].

TIMER PROGRAM	R 2 : 00	SP
10/13 WE	10:12 AM	
CH	DATE	ON OFF
--	---	:- :-

3 Use [▶] to move and change the items with [▲, ▼].

- You may use the numeric buttons to enter "CH".
- **CH** (Program Position/TV Station Name)
- **DATE**
You can also make a daily or weekly program.
- **ON** (start time)/**OFF** (finish time)
The time increases or decreases in 30-minute increments if you hold down the button.
- **Tape speed**
You can also press [REC MODE] to change the recording mode.
SP ↔ EP ↔ VP ↔ A* ↔ SP... (→ 51)
* Auto SP/EP mode (→ 53)

TIMER PROGRAM	R 2 : 00	SP
10/13 WE	10:12 AM	
CH	DATE	ON OFF
6	SA	6:00 PM 7:00 PM
		S P

4 Press [ENTER] when you have finished making changes.

- "☺" lights on the unit's display.
- To continue programming:
Select "NEW TIMER PROGRAM" and repeat steps 2–4.

5 Press [RETURN].

Note

- "☺" and "☹" flashes when the unit cannot perform timer recording (e.g., video cassette with no prevention tab or no video cassette in the cassette compartment).
- The actual time recorded may be longer than the program itself when TV programs are recorded using VCR Plus+ system.
- If you set "DST" (Daylight Saving Time) to "ON" when manually setting the clock (→ 46), timer recording may not work when summer switches to winter and vice versa.

To stop recording while a program is working

Press [■, STOP], then [ENTER] within 5 seconds.

- You can also press and hold [■] on the main unit for more than 3 seconds to stop recording.

Auto SP/EP mode

If, at the beginning of a timer program, there is not enough tape remaining to complete the recording, the SP/EP function will automatically run the tape at EP speed. This ensures that the entire program will be recorded. If EP mode is not enough to stretch the remaining tape to fit the whole program you will not be able to record all of the TV program.

Timer programming

1st program (30 min.)	2nd program (60 min.)	
Video tape		
30 min. at SP	15 min. at SP	45min. at EP

- It is not possible to automatically activate VP mode.
- The tape length must be set correctly. (→ 56)
- Some tapes may not work correctly.
- If the tape speed changes from SP to EP during a timer recording, some brief picture distortion occurs at that point.

Check, change or delete programs

- Even when the unit is turned off, you can display the timer recording list by pressing [PROG/CHECK].

Preparation

- Press [VHS].

1 Press [PROG/CHECK].

CH	DATE	ON	OFF	
6	SA	6:00 PM	7:00 PM	S P
25	13WE	10:12 AM	10:30 AM	S P
NEW TIMER PROGRAM				

2 Press [▲, ▼] to select the program.

3 Press [CANCEL/RESET, *] to delete,

You cannot delete programs that are currently recording.

or press [ENTER] to change.

The timer recording setting screen appears.

4 If you pressed [ENTER] in step 3,

Use [▲, ▼, ◀, ▶] to change and press [ENTER].

5 Press [RETURN].

For your reference

- Programs that failed to record are not deleted from the list immediately, but are deleted from the list automatically at 4 a.m. two days later.

Cautions for using timer recording on DVD and VHS

Timer recording for TV programs cannot be executed on both DVD and VHS at the same time.

Make sure the timer recording start times do not overlap on both DVD (→ 29) and VHS (→ left) timer-programming screens.

When the timer recording settings overlap:

- When the start time of both timer recordings is the same, the timer recording of DVD has priority.
- When tuner channels are specified in timer recordings on both VHS and DVD, only one timer recording can be started.
- When the interval between the first timer recording and the second timer recording on DVD is 1 minute or less as shown below, the second timer recording on DVD has priority over the timer recording on VHS even if its start time is later than the timer recording on VHS.

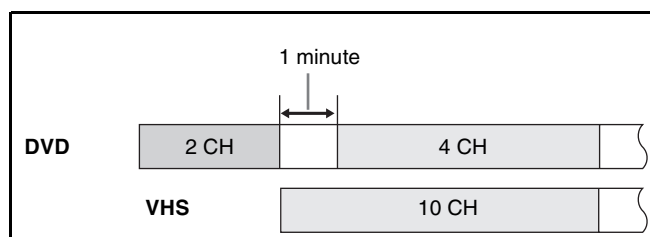

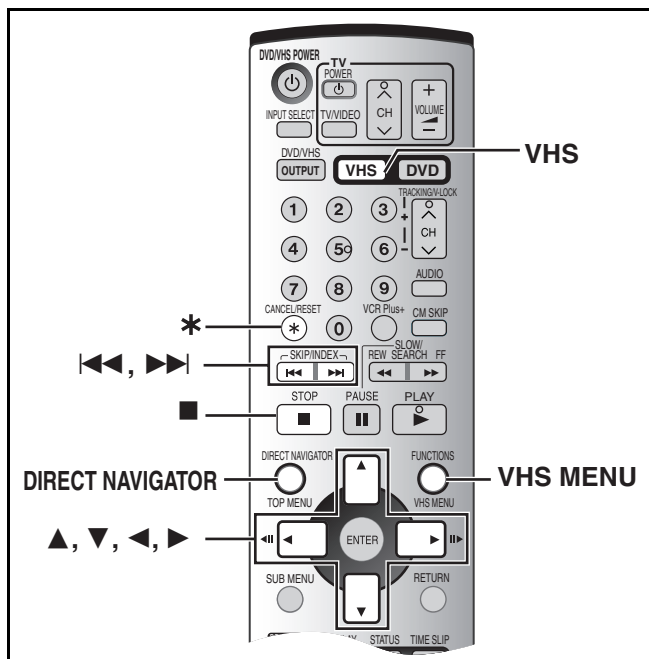

Preparation

- Select the unit viewing channel (or the AV input) on the TV.
- Press [VHS].

Direct Navigator

This unit can display a list of the recorded programs on the inserted tape on the TV screen. You can then select the desired program, and this unit will quickly reach its beginning and start playback.

■ To save Direct Navigator data

Preparation

- The tape length of the inserted tape must be set correctly. (→ 56)
- The unit must not be in timer recording.
- A program of at least 15 minutes must be recorded on the tape.

- 1 Press [VHS MENU] to display the VHS MENU.
- 2 Press [▲, ▼] to select "DIRECT NAVIGATOR" and then select "ON" with [◀, ▶].

VHS MENU		
OSD	● ON	OFF
TAPE SELECT	● T120	T160 T180
BLUE BACK	● ON	OFF
DIRECT NAVIGATOR	● ON	OFF
DELETE NAVIDATA	● NO	YES
JET SEARCH	× 27	● × 35
SELECT : ▲▼ -/+ ◀▶		
END : MENU		

- 3 Record programs (→ 51, 52).

The unit makes the list as you record.

■ Selecting programs to play

- 1 Press [DIRECT NAVIGATOR].

- When [DIRECT NAVIGATOR] is pressed during play, playback stops and the Direct Navigator list appears.

DIRECT NAVIGATOR			
CH	DATE	ON	CATEGORY
1	10/18	10:30 PM	MUSIC
124	10/19	3:00 PM	SPORT
5	10/21	10:15 AM	
A2	10/25	8:30 PM	
		9:30 AM	EDUCA

- 2 Press [DIRECT NAVIGATOR] several times to select the program.

- Every time you press [DIRECT NAVIGATOR], the highlight moves upwards.
- After 3 seconds, the unit starts to search for the beginning of the selected program and playback will start automatically.

■ To cancel the Direct Navigator list

Press [VHS MENU].

■ To delete the Direct Navigator data of a single video cassette tape

Keep [CANCEL/RESET, *] pressed for more than 5 seconds while the Direct Navigator list appears.

"- -" appears on the list.

■ To delete all the Direct Navigator data stored in the unit's memory (→ 56)

■ To Demonstrate the Direct Navigator Function

Keep [DIRECT NAVIGATOR] pressed for more than 5 seconds without inserting a video cassette.

■ Set the category

You can find what kind of programs are recorded with the character and the icon indicators.

Preparation

- Press [VHS].

- 1 Press [DIRECT NAVIGATOR].
- 2 Press [DIRECT NAVIGATOR] several times to select the program and press [▶].
- 3 Press [▲, ▼, ◀, ▶] to select the desired category.
- 4 Press [VHS MENU].

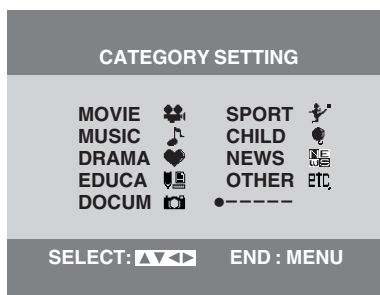

Category	Indicator	Icon
MOVIE	MOVIE	
MUSIC	MUSIC	
DRAMA	DRAMA	
EDUCATION	EDUCA	
DOCUMENTARY	DOCUM	
SPORTS	SPORT	
CHILDREN	CHILD	
NEWS	NEWS	
OTHERS	OTHER	

Note:

- The Direct Navigator list is stored on each tape. Up to 20 tapes and 50 programs can be registered.
- The Direct Navigator program list displays up to 14 programs. If you have already stored 14 programs on a tape and then store another one, the oldest item is replaced.
- Signals approximately 10 seconds before and after the current tape position are checked. During checking, "CHECKING DIRECT NAVIGATOR DATA." is displayed on the TV screen.
- Checking cannot be performed properly where there are no signals, such as unrecorded portions of the tape. In this case, press [DIRECT NAVIGATOR] at a portion of the tape where a program has been recorded on this unit. When a signal still cannot be found, the message "CAN NOT FIND DIRECT NAVIGATOR DATA." appears on the TV.
- "REMAINING PROGRAM 0 DELETE DIRECT NAVIGATOR DATA." appears when you try to store more than 50 programs. The new item is added and the oldest item is deleted.
- "REMAINING CASSETTE 0 FOR DIRECT NAVIGATOR DELETE DIRECT NAVIGATOR DATA." appears when you try to store items for more than 20 tapes. Programs recorded without deleting data as instructed are not registered in the list.
- The list does not appear when playing tapes recorded on other equipment.
- When recording over the same location on a tape, it may not work correctly.

To Check the Recorded Programming Data (Time Stamp Function)

When playback starts after searching with the Direct Navigator function or the index search function, recorded programming data (called Time Stamp) appears on the TV screen for approx. 5 seconds.

Preparation

- Display the unit's picture on the TV.
- Press [VHS].
- Be sure to set "OSD" in the "VHS MENU" to "ON". (→ 56)

On Screen Display

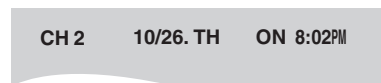

Note:

- Time Stamp may not appear if the beginning of the Direct Navigator data is not recorded 25 minutes before and after the current tape position even when index signals are recorded.

VHS Index Search System (VISS)

This unit automatically records special index signals on the tape every time a recording is started. The index search function makes use of these index signals to let you find the beginning of a desired program quickly and easily.

■ Index signals are recorded in the following cases.

- When a recording is started by pressing [●, VHS REC].
- When timer recording is activated.

Preparation

- Display the unit's picture on the TV.
- Press [VHS].
- Insert a recorded video cassette.

While stopped or during normal play

Press [◀◀] or [▶▶].

- Each press increases the number of skips.



■ To cancel the Index Search or to stop playback

Press [■, STOP].

Note:

- Up to 20 index signals can be searched for in both directions.
- When you press either one of the button too much, you can control the number of skips by pressing the opposite button.
- The figure on the display decreases by 1 each time an index signal is located.
- This feature may not work correctly if the marks are too close together. Make recordings of at least 5 minutes.

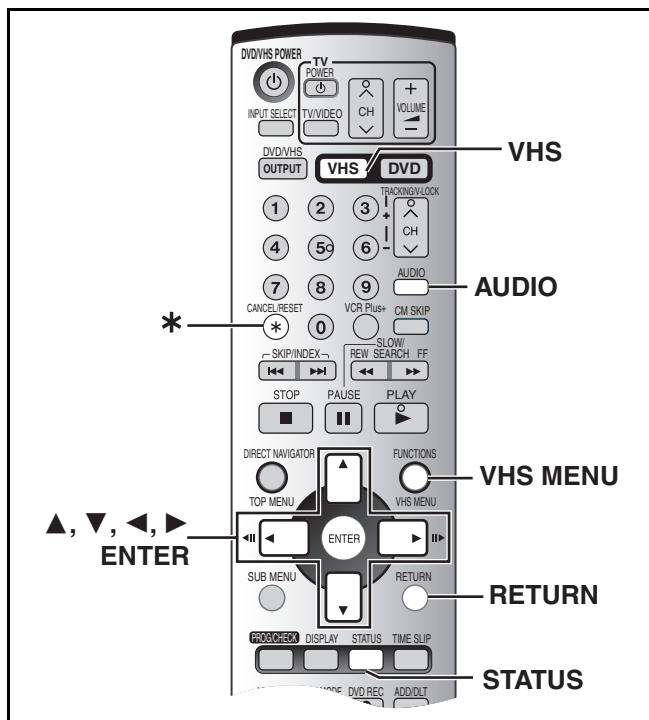

Summary of settings

This description shows the initial settings for this unit. For details on menu operation (→ left).

- Underlined items are the factory presets.

■ VHS MENU

OSD (→ 57)

[ON] [OFF]

ON	Messages appear on the TV for about 5 seconds after you perform operations. • The on screen display will always appear on the TV screen during rewind, Jet Rewind and fast forward.
OFF	Messages do not appear.

TAPE SELECT

Set the length of tape you are using so the unit can show the correct remaining time.

[T120] [T160] [T180]

[T120]: T30, T60, T90 and T120 tapes

[T160]: T140 and T160 tapes

[T180]: T180 tapes

BLUE BACK

[ON] [OFF]

ON	The screen shows a blue background when you play unrecorded portions.
Off	The blue background function is deactivated.

DIRECT NAVIGATOR (→ 54)

[ON] [OFF]

ON	Direct Navigator data automatically registered.
OFF	Data not registered.

DELETE NAVIDATA

Delete all the Navigation data registered in the unit.

- To delete data on a single tape (→ 54).

[NO] [YES]

[YES]: Then press [ENTER] when you want to delete all the Direct Navigator data.

JET SEARCH (→ 49)

Set the speed for JET SEARCH when playing EP and VP tapes.

- It is possible to view the picture recorded in EP or VP mode at approx. 27 or 35 times speed.

[×27] [×35]

[×27]: Select [×27] if the picture is poor at [×35]

Changing the unit's settings

Preparation

- Press [VHS].

■ Common procedures

1 While stopped

Press [VHS MENU].

VHS MENU			
OSD		● ON	OFF
TAPE SELECT	● T120	T160	T180
BLUE BACK	● ON	OFF	
DIRECT NAVIGATOR	ON	● OFF	
DELETE NAVIDATA	● NO	YES	
JET SEARCH	× 27	● × 35	
SELECT : ▲▼ -/+ ◀▶			
END : MENU			

2 Use [▲, ▼] to select a desired item.

3 Use [◀, ▶] to change the setting.

■ To exit the settings screen

Press [VHS MENU]

Preparation

- Press [VHS].

Various on-screen display indications

To see these displays, set the "OSD" item in the "VHS MENU" to "ON" (→ 56).

Press [STATUS].

The time and operation details appear on the screen for about 5 seconds.

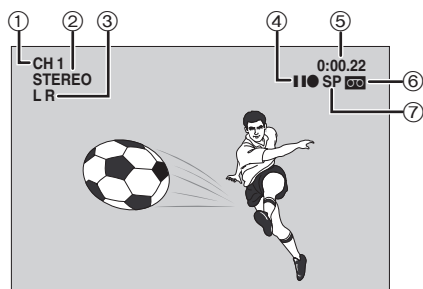

①	Channel display
②	STEREO/SAP indication Indicates when a program is broadcast in stereo or SAP.
③	L and R indicators (appears only in playback) The Left (L) and Right (R) indicators show which sound mode is selected as follows: Stereo: Both the L and R indicators appear. L: The L indicator appears. R: The R indicator appears. Normal: Neither the L nor R indicator appears.
④	Operation status display
⑤	Shows the time and tape counter Pressing [STATUS] once makes the on-screen display appear. After that, press the button repeatedly to change the display as follows: Present time → Tape counter → Remaining tape time → Present time during Index search: "S 01" to "S 20" is displayed. during Jet Rewind: "J. REW" is displayed. • Press [CANCEL/RESET, *] to reset the tape counter (elapsed time) to "0:00.00". The tape counter is automatically reset to "0:00.00" when inserting a video cassette. • The remaining time is approximate. It will be incorrect if you set the wrong tape time in the "TAPE SELECT" item in the "VHS MENU" and if the tape is of poor quality.
⑥	Cassette-in indicator Shows whether you have loaded a video cassette.
⑦	Tape speed indicator (→ 51)

Note:

- These displays do not appear when paused or during slow play.
- The on-screen display may be distorted depending on the playback tape or the input signal.

Changing audio

When a stereo and/or SAP broadcast is received, "STEREO" or "SAP" light to show the type of broadcast.

■ When playing a tape:

To change the audio, press [AUDIO].

The audio changes as follows:

Stereo → L → R → Normal audio track → Stereo

■ While watching TV:

You cannot change audio.

Auto Bilingual Choice Function

When a stereo broadcast or SAP broadcast is recorded and played back on this unit, stereo sound will be automatically selected in the case of a stereo broadcast and SAP sound will be automatically selected in the case of a dual-sound broadcast (Mono and SAP or Stereo and SAP).

- The wrong choice may be made if the program is played back from an interim point. (In a case like this, press [AUDIO] and select the right sound only in playback.)
- The function will not work with a cassette which has been recorded using external equipment.

Transfer (Dubbing) from VHS

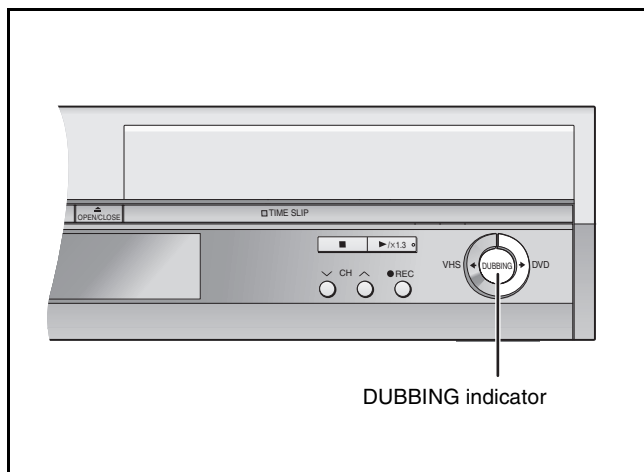
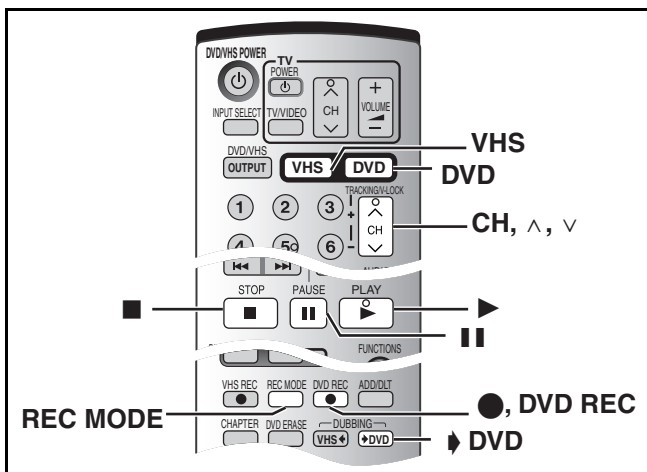

■ One Touch Transfer (Dubbing) (VHS → DVD)

RAM DVD-R

You can transfer (dubbing) programs recorded on a tape onto a disc* with one stroke of the button.

In One-Touch Dubbing, programs are automatically dubbed onto the disc from the location of playback on the tape.

* Available discs for transfer (dubbing) from tape are DVD-RAM and non-finalized DVD-R.

Preparation

- Select the unit viewing channel (or the AV input) on the TV.

DVD

- Release protection (disc → 30, cartridge → 18). **RAM**
- Insert a disc and confirm there is sufficient empty space for recording on it. (→ 20, 47)
- Select the recording mode.
- When SAP broadcast program is played back on VHS, the audio on DVD is recorded according to the settings in "Select MTS" in the initial settings. (→ 44) **DVD-R**

VHS

- Insert the video cassette containing the program to be copied (→ 48).

- 1 While both DVD/VHS are stopped, **Press and hold [▶ DVD, DUBBING] for 3 seconds or more.**

On the main unit, press [▶ DVD].

- Check if transfer (dubbing) starts properly.
- The "DUBBING" indicator on the main unit lights.
- Dubbing is automatically completed when the tape reaches its end or the disc becomes full.

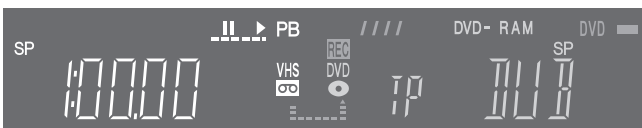

■ To stop transfer (dubbing) halfway through

Press [■, STOP].

- When transfer (dubbing) is completed, a message indicating the end of transfer (dubbing) appears on the TV screen and then disappears a few seconds later.

■ When transfer (dubbing) is started, the following operations also start automatically

- "OSD" on VHS MENU → "OFF" (→ 56)
- Recording channel indicator on DVD → "TP"
- Output to TV → DVD output

■ Only the following operations are allowed while transfer (dubbing)

- Stopping transfer (dubbing) by pressing [■, STOP].

Note:

- While One Touch Transfer (Dubbing) is activated, a timer recording cannot be started.
- When "DVD/VHS Output" is set to "Manual" (→ 43), or when VHS output is selected in starting transfer (dubbing), the output is switched to DVD automatically at the time when transfer (dubbing) is started.
 - When the transfer (dubbing) is already started, you cannot switch the output manually.
- When the transfer (dubbing) is not started or not executed, the "DUBBING" indicator blinks for about 7 seconds. Check if the unit is properly prepared.
- When a Copy-guarded tape is inserted, a message appears on the display and the recording stops on the spot.
- If a part of the tape recorded in VP mode is dubbed to disc, noises may appear at the beginning of the dubbed part.

■ Dividing a title to be dubbed

In One-Touch Transfer (Dubbing) from VHS to DVD, the title is divided by index signal detected and then recorded. You can search desired titles with Direct Navigator's Title View (→ 33) after transfer (dubbing) to DVD.

- Titles recorded within 15 minutes (25 minutes in VP mode) of each other may not be divided properly.
- The recording time may become longer than the original title depending on the number of index signals.

Manual Transfer (Dubbing)

RAM DVD-R

You can specify the position to start transfer (dubbing) of the program recorded on the tape to the disc.

- Available discs for transfer (dubbing) from tape are DVD-RAM and non-finalized DVD-R.
- Copy-guarded video tapes cannot be dubbed. Most video tapes are copy-guarded to prevent illegal reproduction and they cannot be recorded with the following procedure.

Preparation

- Select the unit viewing channel (or the AV input) on the TV.

DVD

- Release protection (disc → 30, cartridge → 18). **RAM**
- Insert a disc and confirm there is sufficient empty space for recording on it. (→ 20, 47)

VHS

- Insert the video cassette containing the program to be copied (→ 48).
- Check the channel. If “DC” channel is selected, transfer (dubbing) does not work properly.
 - When the “DC” channel is selected on VHS, you cannot select the “TP” channel.

1 Press [VHS] and press [▶, PLAY].

Start playing the video cassette and find the recording start point.

- Select the audio to be played (the audio to be recorded) beforehand.

2 Press [II, PAUSE] at the start point of the recording.

3 Press [DVD].

4 Select “TP” channel with [CH, ^, v].

- The VHS picture is displayed on the TV.

5 Press [REC MODE] to select the recording mode.

6 Press [●, DVD REC].

- Disc recording and VHS play start at the same time.

To pause or stop Manual Transfer (Dubbing)

You cannot stop or pause on DVD and VHS at the same time

■ To pause or stop recording

Press [DVD] and press [II, PAUSE] or [■, STOP].

■ To pause or stop play

Press [VHS] and press [II, PAUSE] or [■, STOP].

■ When transfer (dubbing) is started, the following operations also start automatically

- “OSD” on VHS MENU → “OFF” (→ 56)

■ Only the following operations are allowed while transferring (dubbing)

- Turning the unit off/on
- Stopping transfer (dubbing) by pressing [STOP]

Note:

- When the transfer (dubbing) is already started, you can switch the output manually.
- When a Copy-guarded tape is inserted, the message appears on the display and the recording stops on the spot.
- If a part of the tape recorded in VP mode is dubbed to disc, noises may appear on the beginning of the dubbed part.

■ About TP channel

(TP: Dubbing input channel)

- TP channel can be recorded only when the DVD input channel is set to “TP”.
- When you play back a tape turning the channel to “TP”, the picture on VHS is displayed on the TV screen.

Transfer (Dubbing) from DVD

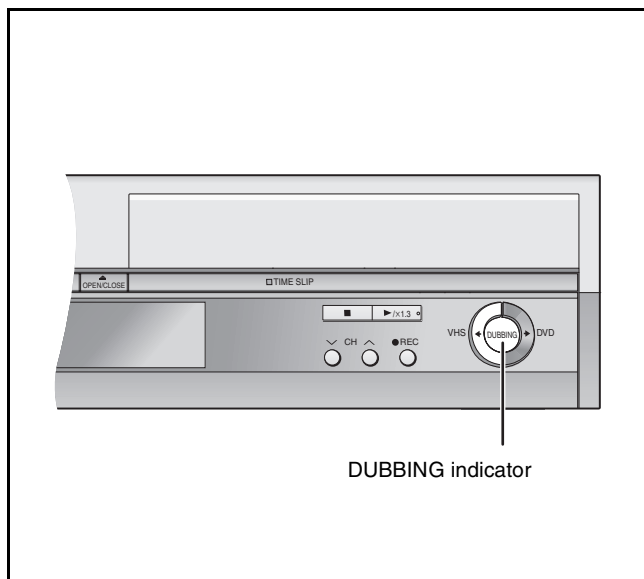
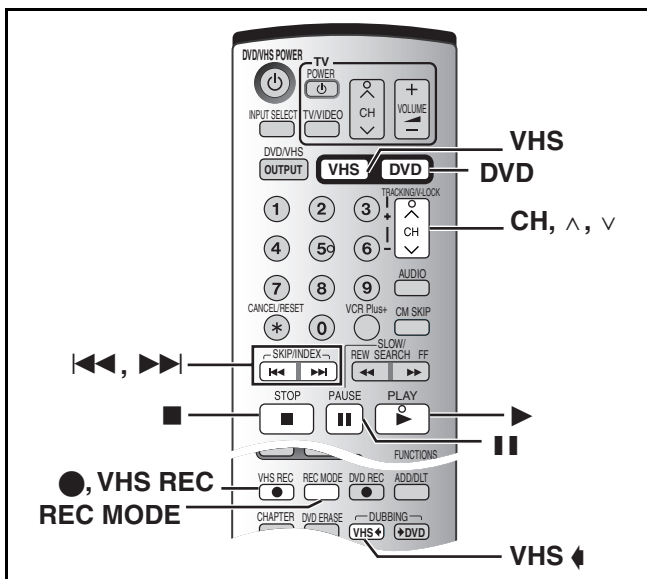

■ One Touch Transfer (Dubbing) (DVD → VHS)

You can transfer (dubbing) programs recorded on a disc* onto a tape with one stroke of the button.

In One-Touch Dubbing, all contents on the disc are automatically dubbed onto the tapes.

* Available discs for transfer (dubbing) onto tape are DVD-RAM and non-finalized DVD-R. Most DVD videos cannot be dubbed because they are copy-guarded.

Preparation

- Select the unit viewing channel (or the AV input) on the TV.

DVD

- Insert the disc containing the program to be copied (→ 20).

VHS

- Insert a video cassette with an intact erasure prevention tab. (→ 48)
- Confirm that the remaining tape time is sufficient for recording. (→ 57)
- Select the recording mode.

- 1 While both DVD/VHS are stopped, Press and hold [VHS ↵, DUBBING] for 3 seconds or more.

On the main unit, press [VHS ↵].

- Check if transfer (dubbing) starts properly.
- The [DUBBING] indicator on the main unit lights.
- Dubbing is automatically completed when playback of the disc is finished or the tape reaches its end.



■ To stop transfer (dubbing) halfway through

Press [■, STOP].

- When transfer (dubbing) is completed, a message indicating the end of transfer (dubbing) appears on the TV screen and then disappears a few seconds later.

■ When transfer (dubbing) is started, the following operations also start automatically:

- "Status Messages" on Display → "Off" (→ 45)
- Recording channel indication on VHS → "DC"
- Output to TV → VHS output
- Audio output when playing back DVD → Stereo (L R) **RAM**

■ Only the following operations are allowed while transfer (dubbing):

- Stopping transfer (dubbing) by pressing [■, STOP].

Note:

- While One Touch Transfer (Dubbing) is activated, timer recording cannot be started.
- When "DVD/VHS Output" is set to "Manual" (→ 43), or when DVD output is selected in starting transfer (dubbing), the output is switched to VHS automatically at the time when transfer (dubbing) is started.
 - When the transfer (dubbing) is already started, you cannot switch the output manually.
- When the transfer (dubbing) is not started or not executed, the "DUBBING" indicator blinks for about 7 seconds. Check if the unit is properly prepared.
- If you start transfer (dubbing) when "PB" is blinking on the unit's display, the DVD is dubbed from the beginning of the title which you stopped.

■ About Recording VISS (→ 55)

In One-Touch Dubbing from DVD to VHS, the index signal is automatically recorded for each title. You can search desired titles with [◀◀] or [▶▶].

■ Manual Transfer (Dubbing)

You can specify the position to start transfer (dubbing) of the program recorded on the disc to the tape.

- Copy-guarded discs cannot be dubbed. Most discs are copy-guarded to prevent illegal reproduction and they cannot be recorded with the following procedure.

Preparation

- Select the unit viewing channel (or the AV input) on the TV.

DVD

- Insert the disc containing the program to be copied (→ 20).
- Check the channel. If "TP" channel is selected, transfer (dubbing) does not work properly.
 - When the "TP" channel is selected on DVD, you cannot select the "DC" channel.

VHS

- Insert a video cassette with an intact erasure prevention tab. (→ 48)
- Confirm that the remaining tape time is sufficient for recording. (→ 57)

1 Press [DVD] and press [▶, PLAY].

Start playing the disc and find the recording start point.

- Select the audio to be played (the audio to be recorded) beforehand. **RAM**
- When the DVD-R is inserted, you cannot select the audio.

2 Press [⏏, PAUSE] at the start point of the recording.

3 Press [VHS].

4 Select "DC" channel with [CH, ^, v].

- The DVD picture is displayed on the TV.

5 Press [▶, PLAY].

Start playing the video cassette and find the recording start point.

6 Press [⏏, PAUSE] at the start point of the recording, then press [●, VHS REC] to pause.

Put the unit in the recording standby mode.

7 Press [REC MODE] to select the recording mode.

8 Press [⏏, PAUSE].

- VHS recording and disc play start at the same time.

To pause or stop Manual Transfer (Dubbing)

You cannot stop or pause on DVD and VHS at the same time

■ To pause or stop recording

Press [VHS] and press [⏏, PAUSE] or [■, STOP].

■ To pause or stop play

Press [DVD] and press [⏏, PAUSE] or [■, STOP].

■ When transfer (dubbing) is started, the following operations also start automatically:

- "Status Messages" on Display → "Off" (→ 45)
- Audio output when playing back DVD → Stereo (L R)

■ Only the following operations are allowed while transfer (dubbing):

- Turning the unit off/on
- Stopping transfer (dubbing) by pressing [STOP]

Note:

- When the transfer (dubbing) is already started, you can switch the output manually.

■ About DC channel

(DC: Dubbing input channel)

- DC channel can be recorded only when the VHS input channel is set to "DC".
- When you play back a tape with the channel set to "DC", the DVD picture is displayed on the TV screen.

Recording from an external device

When connecting to the L2 input terminals on the front of the unit

- You can also connect to the L1 input terminals on the rear of the unit.

Before connecting any cables, first make sure that the power for both units is off. Then, after connecting cables, turn on both units.

Note

- When recording using this unit's input terminals, only the sound received at the time of recording will be recorded. As long as secondary audio that is recorded on the media in the external device is not output to the unit in play, it is not recorded.
- If the audio output of the other equipment is monaural, connect to L/MONO. (Both left and right channels are recorded when connected through L/MONO.)
- The S-VIDEO terminal achieves a more vivid picture than the VIDEO terminal.

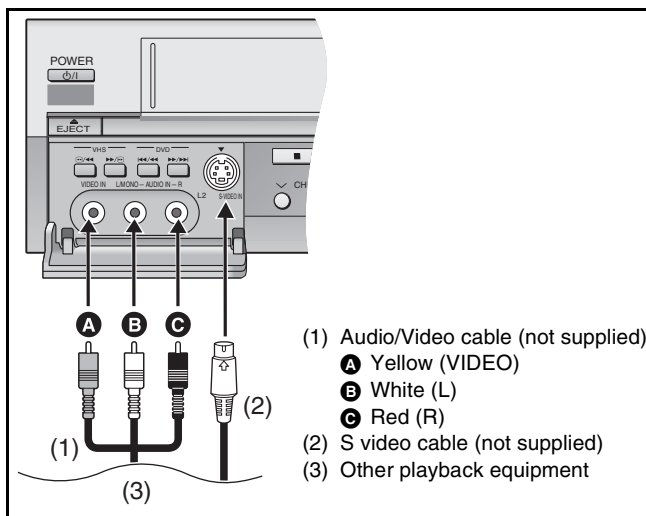

Preparation

DVD **RAM** **DVD-R**

- Release protection (disc → 30, cartridge → 18). **RAM**
- Press [DVD].

VHS

- Insert a video cassette with an intact erasure prevention tab. (→ 48)
- Press [VHS].

1 Press [REC MODE] to select the recording mode.
 (DVD → 27, VHS → 51)

● **DVD RAM** **DVD-R**

- It is also possible to perform Flexible Recording (FR). (→ 27)

2 While stopped

Press [CH, ^, v] or [INPUT SELECT] to select the input channel.

- Select L1 or L2.

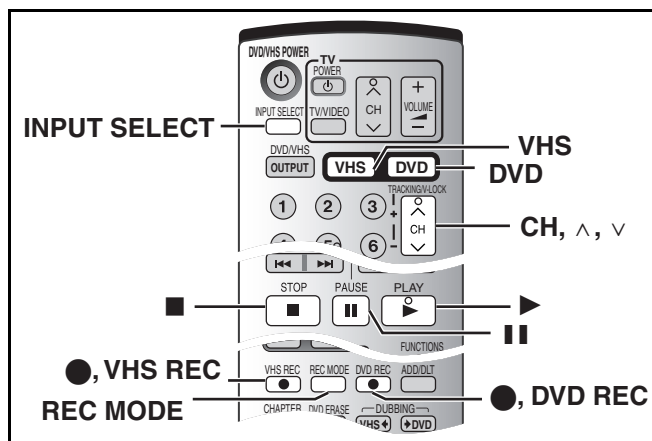

▶ DVD

3 Start play on the other equipment.

4 Press [●, DVD REC] at the point where you want to start recording.

▶ VHS

3 Press [▶, PLAY].

Start playing the video cassette and find the recording start point.

4 Press [||, PAUSE], then press [●, VHS REC].

Put the unit in recording standby mode.

5 Start play on the other equipment.

6 Press [||, PAUSE] at the point where you want to start recording.

■ To skip unwanted parts

Press [||, PAUSE] to pause recording. (Press again to restart recording.)

■ To stop recording

Press [■, STOP].

For your reference

- Almost all videos and DVD software on sale have been treated to prevent illegal copying. Such software cannot be recorded.

Glossary

Bitstream

This is the digital form of multi-channel audio data (e.g., 5.1 channel) before it is decoded into its various channels.

CPRM (Content Protection for Recordable Media)

CPRM is technology used to protect broadcasts that are allowed to be recorded only once. Such broadcasts can be recorded only with CPRM compatible recorders and discs.

Dynamic range

Dynamic range is the difference between the lowest level of sound that can be heard above the noise of the equipment and the highest level of sound before distortion occurs. Dynamic range compression means reducing the gap between the loudest and softest sounds. This means you can listen at low volumes but still hear dialog clearly.

Film and video

DVD-Videos are recorded using either film or video. This unit can determine which type has been used, then uses the most suitable method of progressive output.

- Film is 24 or 30 frames per second, with motion picture film generally being 24 frames per second.
- Video is 60 fields per second (two fields making up one frame).

Finalize

A process that makes play of a recorded CD-R, CD-RW, DVD-R etc. possible on equipment that can play such media. You can finalize DVD-R on this unit.

Formatting

Formatting is the process of making media such as DVD-RAM recordable on recording equipment. You can format DVD-RAM on this unit. Formatting irrevocably erases all recordings on the disc.

Frame and field

Frame refers to the single images that constitute the video you see on your TV. Each frame consists of two fields.

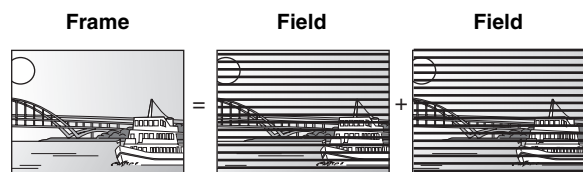

- A frame still shows two fields, so there may be some blurring, but picture quality is generally better.
- A field still shows less picture information so it may be rougher, but there is no blurring.

Linear PCM (LPCM)

These are uncompressed digital signals. CDs are recorded with 44.1 kHz/16 bit PCM, while DVDs use PCM between 48 kHz/16 bit and 96 kHz/24 bit, allowing playback with greater quality sound.

The linear PCM signals output from the DIGITAL AUDIO OUT OPTICAL terminal are stereo (2 channel). LPCM sound is available when recording in XP mode.

Title/Chapter (DVD-Video)

DVD-Video are divided into large sections (titles) and smaller sections (chapters). The numbers allocated to these sections are called title numbers and chapter numbers.

Example

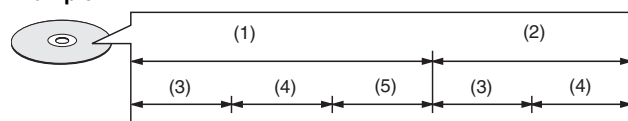

- (1) Title 1
- (2) Title 2
- (3) Chapter 1
- (4) Chapter 2
- (5) Chapter 3

MP3 (MPEG Audio Layer 3)

An audio compression method that compresses audio to approximately one tenth of its size without any considerable loss of audio quality. You can play MP3s you have recorded onto CD-R and CD-RW.

Pan & Scan/Letterbox

In general, DVD-Video are produced with the intention that they be viewed on a widescreen TV (16:9 aspect ratio), so images often don't fit regular (4:3 aspect ratio) TVs. Two styles of picture, "Pan & Scan" and "Letterbox", deal with this problem.

Pan & Scan: The sides are cut off so the picture fills the screen.



Letterbox: Black bands appear at the top and bottom of the picture so the picture itself appears in an aspect ratio of 16:9.



Playback control (PBC)

If a Video CD has playback control, you can select scenes and information with menus.

(This unit is compatible with version 2.0 and 1.1.)

Progressive/Interlace

NTSC, the video signal standard, has 480 interlaced (I) scan lines, whereas progressive scanning uses twice the number of scan lines. This is called 480P.

Using progressive output, you can enjoy the high-resolution video recorded on media such as DVD-Video.

Your TV must be compatible to enjoy progressive video.

Protection

You can prevent accidental erasure by setting writing protection or erasure protection.

Sampling frequency

Sampling is the process of converting the heights of sound wave (analog signal) samples taken at set periods into digits (digital encoding). Sampling frequency is the number of samples taken per second, so larger numbers mean more faithful reproduction of the original sound.

VBR (Variable Bitrate)

This is a method of video recording that adjusts the bit rate according to video signal.

Track

This is the smallest division on CD and Video CD.

Example

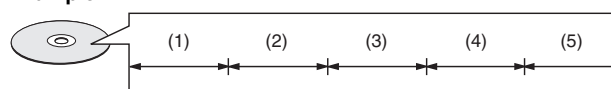

- (1) Track 1
- (2) Track 2
- (3) Track 3
- (4) Track 4
- (5) Track 5

Frequently asked questions

Set up

		Page
What equipment is necessary to play multi channel surround sound?	<ul style="list-style-type: none"> •DVD-Video: You can play DVD-Video multi channel surround by digitally connecting an amplifier equipped with a Dolby Digital and a DTS decoder. •DVD-Audio: This unit plays DVD-Audio in 2 channels. You cannot play multi channel surround sound. 	12 –
Are the headphones and speakers directly connected to the unit?	<ul style="list-style-type: none"> •You cannot directly connect to the unit. Connect through the amplifier etc. 	12
The TV has both S-VIDEO IN terminal and COMPONENT VIDEO IN terminals. Which terminal should I connect with?	<ul style="list-style-type: none"> •We recommend the COMPONENT VIDEO IN terminal. Component signal outputs the color difference signals (PB/PR) and luminance signal (Y) separately in order to achieve high fidelity in reproducing colors. If the TV is compatible with progressive output, a high quality picture can be output because this unit's component video output terminal outputs a progressive output signal. 	10
Is my TV progressive output compatible?	<ul style="list-style-type: none"> •All Panasonic TV that have 480P input terminals are compatible. Consult the manufacturer if you have another brand of TV. 	–

Disc

		Page
Can I play DVD-Video, DVD-Audio and Video CDs bought in another country?	<ul style="list-style-type: none"> •You can play them if the video standard is NTSC. •However, you cannot play DVD-Video if their region number does not include "1" or "ALL". 	– 18
Can a DVD-Video that does not have a region number be played?	<ul style="list-style-type: none"> •The DVD-Video region number indicates the disc conforms to a standard. You cannot play discs that do not have a region number. 	–
Please tell me about DVD-R and DVD-RW compatibility with this unit.	<ul style="list-style-type: none"> •This unit records and plays DVD-R. However, you cannot record onto DVD-R discs that are finalized. •This unit also records and plays 1×–4× recording speed DVD-R discs. •This unit does not record or play DVD-RW. 	18 18 18
Please tell me about CD-R and CD-RW compatibility with this unit.	<ul style="list-style-type: none"> •You can play CD-R and CD-RW on this unit that are created using a compatible format. •You cannot write to a CD-R or CD-RW with this unit. 	18, 24 18

Recording

		Page
Can I record from a commercially purchased video cassette or DVD?	<ul style="list-style-type: none"> •Most commercially sold video cassettes and DVD are copy protected; therefore, recording is usually not possible. 	–
Can a DVD-R recorded on this unit be played on other equipment?	<ul style="list-style-type: none"> •You can play on DVD-R compatible players after finalizing the disc on this unit; however, due to the condition of the recording, play may not be possible. 	31
How many times can I write to a DVD-RAM disc?	<ul style="list-style-type: none"> •You can write to the disc approximately 100,000 times depending upon the conditions of use. 	–
Can I record digital audio signals using this unit?	<ul style="list-style-type: none"> •You cannot record digital signals. The digital audio terminals on this unit are for output only. 	–
Can a digital audio signal from this unit be recorded to other equipment?	<ul style="list-style-type: none"> •You can record if using the PCM signal. When recording DVD, change the "Digital Audio Output" settings to the following from the SETUP menu. <ul style="list-style-type: none"> - PCM Down Conversion "ON" - Dolby Digital "PCM" - DTS "PCM" However, only <ul style="list-style-type: none"> - As long as digital recording from the disc is permitted. - As long as the recording equipment is compatible with a sampling frequency of 48 kHz. •You cannot record MP3 signals. 	44 –
Can I switch to MTS during recording?	<ul style="list-style-type: none"> •With DVD-RAM, you can, and the audio recorded also changes. Just press [AUDIO]. •With DVD-R, you cannot. Change before recording with the "Select MTS" in the SETUP menu. 	27 44

Error messages

Common

On the unit's display		Page
H□□, F□□ (“□□” stands for a number.)	<ul style="list-style-type: none"> An error has occurred. The number following “H” or “F” depends on the status of the unit. <p>Reset procedure: Press [POWER ⏻/I] to switch the unit to standby mode and then back to ON. Alternatively, press [POWER ⏻/I] to switch the unit to standby mode, disconnect the AC power supply cord, and then reconnect it.</p> <ul style="list-style-type: none"> If the service numbers fail to clear, note the service numbers and contact a qualified service person. 	–

DVD

On the TV		Page
Cannot finish recording completely.	<ul style="list-style-type: none"> The program was copy-guarded. The disc may be full. 	–
Cannot play.	<ul style="list-style-type: none"> You inserted an incompatible disc (Discs recorded in PAL video, etc.). 	–
Cannot record on the disc.	<ul style="list-style-type: none"> The disc may be dirty or scratched. 	19
Unable to format. Please check the disc.		
Cannot record. Disc is full.	<ul style="list-style-type: none"> Create space by erasing any unwanted titles. RAM 	23, 33, 37
Cannot record. Maximum number of titles exceeded.	<ul style="list-style-type: none"> Use a new disc. RAM DVD-R 	–
Error has occurred. Please press ENTER.	<ul style="list-style-type: none"> Press [ENTER] to start recovery process. You cannot operate the unit while it is recovering (“SLF CHECK” appears on the unit's display). 	–
No disc.	<ul style="list-style-type: none"> You haven't inserted a disc. Correctly insert a disc that this unit can play. The disc is upside down. If it is a single-sided disc, insert it so the label is facing up. 	18, 20 20
Please change the disc.	<ul style="list-style-type: none"> There may be a problem with the disc. Press [▲, OPEN/CLOSE] to remove it and check it for scratches or dirt. (The unit turns off automatically after you open the tray.) 	19
This is a non-recordable disc.	<ul style="list-style-type: none"> The unit cannot record on the disc you inserted. Insert a DVD-RAM or unfinalized DVD-R. 	–
This disc is not formatted properly.	<ul style="list-style-type: none"> You inserted an unformatted DVD-RAM. Format the disc with this unit. 	31
⊘	<ul style="list-style-type: none"> The operation is prohibited by the unit or disc. 	21

On the unit's display		Page
□ CHK REMOTE (“□” stands for a number.)	<ul style="list-style-type: none"> The remote control and main unit are using different codes. Change the code on the remote control or main unit. 	17
HARD ERR	<ul style="list-style-type: none"> If there is no change after turning the unit on and off, consult the dealer where the unit was purchased. 	–
NO READ	<ul style="list-style-type: none"> The disc is dirty or badly scratched. The unit cannot record, play, or edit. You have used a DVD-RAM/PD lens cleaner and it has finished. Press [▲, OPEN/CLOSE] to eject the disc. 	19 19
PROG FULL	<ul style="list-style-type: none"> There are already 16 timer programs. Delete unnecessary timer programs. 	29, 53
SLF CHECK	<ul style="list-style-type: none"> There was a power failure or the AC plug was disconnected while the unit was on. The unit is carrying out its recovery process. Wait until the message disappears. 	–
UNSUPPORT	<ul style="list-style-type: none"> You have inserted a disc the unit cannot play or record on. 	19
U14	<ul style="list-style-type: none"> The unit is hot. The unit switches to standby for safety reasons. Wait for about 30 minutes until the message disappears. Select a position with good ventilation when installing the unit. Do not block the cooling fan on the rear of the unit. 	–
U99	<ul style="list-style-type: none"> The unit fails to operate properly. Press [POWER ⏻/I] on the main unit to switch the unit to standby. Now press [POWER ⏻/I] again to turn the unit on. 	–

VHS

On the TV		Page
PLEASE PUT IN A VIDEO CASSETTE.	<ul style="list-style-type: none"> A video cassette is not inserted when recording programs or setting the timer recording. Insert a video cassette with an intact erasure prevention tab. 	48
PLEASE SET THE CLOCK	<ul style="list-style-type: none"> The clock is not set when recording programs or setting the timer recording. Set the clock. 	46
PLEASE USE A CASSETTE WITH TAB.	<ul style="list-style-type: none"> A video cassette without the intact erasure prevention tab is inserted when recording programs or setting the timer recording. Use a video cassette with an intact erasure prevention tab. 	48

Helpful Hints



Picture		Page
TV reception worsens after connecting the unit.	<ul style="list-style-type: none"> This can occur because the signals are being divided between the unit and other equipment. It can be solved by using a signal booster, available from audio-visual suppliers. 	–
The images from this unit do not appear on the TV.	<ul style="list-style-type: none"> Make sure that the TV is connected to the VIDEO OUT terminal, S-VIDEO OUT terminal or COMPONENT VIDEO OUT terminals on this unit. 	10
Picture is distorted.	<ul style="list-style-type: none"> Make sure that the TV's input setting (e.g., VIDEO 1) is correct. The TV isn't compatible with progressive signals. Press and hold [■, STOP] and [▶ DVD, DUBBING] on DVD of the main unit at the same time for about 5 seconds. The setting will change to interlace. 	– –

Recording, Timer recording, Transfer (dubbing), External input		Page
Timer recording does not work properly.	<ul style="list-style-type: none"> When connected to cable TV box or satellite receiver, the VCR Plus+ system does not work. The timer program is incorrect or different timer program times overlap. Correct the program. The clock is not correct. Set the clock. 	– 29, 53 46
VCR Plus+ system does not work properly.	<ul style="list-style-type: none"> Correct the guide channels with "VCR Plus+ CH Setting" in the SETUP menu. The same guide channel is set to 2 or more channel positions. Set the guide channel correctly or delete unnecessary channels. Timer recording will not be activated during formatting, transfer (dubbing) and other such operations which should not be interrupted when they are being carried out. 	15 15 –
Timer recording does not stop even when [■, STOP] is pressed.	<ul style="list-style-type: none"> Press [■, STOP] and then [ENTER] within 5 seconds to turn "⊖" off. Recording stops. 	29, 52
The timer program remains even after recording finishes.	<ul style="list-style-type: none"> The timer program remains if set to daily or weekly. 	28, 52
Cannot transfer (dub) VHS to a disc.	<ul style="list-style-type: none"> "TP" channel is not selected when recording from a video tape to a disc. Some video tapes on the market (including rental videos) are copy-guarded to prevent illegal reproductions. Copy-guarded video tapes cannot be properly recorded. 	59 –
Cannot record video or sound from a disc.	<ul style="list-style-type: none"> "DC" channel is not selected when recording from a disc to a video tape. Most DVDs on the market (including rental DVDs) are copy-guarded to prevent illegal reproductions. Copy-guarded DVDs cannot be properly recorded. 	61 –
The sound level after editing is not equal on DVD and on VHS.	<ul style="list-style-type: none"> The sound level on DVD and VHS may not match depending on the disc. When the sound level in a particular part of the sound source is soft or loud, the sound may be recorded loudly or softly on a video tape. 	–
Strip-shaped black noise is recorded.	<ul style="list-style-type: none"> The device in playback is interfered with by the TV because the device is too close to the TV. Move the device away from the TV. 	–
Cannot record video or sound from the external device.	<ul style="list-style-type: none"> The external device is not correctly connected. The proper external input channel (L1 or L2) is not selected. 	62 62

Helpful Hints



■ DVD

DVD Picture		Page
Status messages do not appear.	<ul style="list-style-type: none"> Select "Automatic" in "Status Messages" in the SETUP menu. 	45
The blue background does not appear.	<ul style="list-style-type: none"> Select "On" in "Blue Background" in the SETUP menu. 	45
The 4:3 aspect ratio picture expands left and right.	<ul style="list-style-type: none"> Use the TV to change the aspect. If your TV does not have that function, set "Progressive" in the Video menu to "OFF". 	41
Screen size is wrong.	<ul style="list-style-type: none"> Check the settings for "TV Type", "4:3 TV Settings for DVD-Video" or "4:3 TV Settings for DVD-RAM" in the SETUP menu. 	45
There is a lot of after-image when playing video.	<ul style="list-style-type: none"> Set "MPEG-DNR" in the Video menu to "OFF". 	41
When playing DVD-Video using progressive output, one part of the picture momentarily appears to be doubled up.	<ul style="list-style-type: none"> Set "Progressive" in the Video menu to "OFF". This problem is caused by the editing method or material used on DVD-Video, but should be corrected if you use interlace output. 	41
There is no apparent change in picture quality when adjusted with the Video menu in the on-screen menus.	<ul style="list-style-type: none"> The effect is less perceivable with some types of video. 	41

DVD Sound		Page
No sound. Low volume. Distorted sound. Cannot hear the desired audio type.	<ul style="list-style-type: none"> Check the connections and settings. Check the input mode on the amplifier if you have connected one. Press [AUDIO] to select the audio. Turn off V.S.S. in the following cases. <ul style="list-style-type: none"> When using discs that do not have surround sound effects such as Karaoke discs. When playing MTS broadcast programs. 	10–12, 44 23, 27 41
Cannot switch audio.	<ul style="list-style-type: none"> You cannot change the audio type when a DVD-R is in the disc tray. You cannot change the audio type when playing a DVD-R. (You can select "Main" or "SAP" in "Select MTS" in the SETUP menu before recording.) You have used a digital connection. Set "Dolby Digital" to "PCM" or connect using audio cables (analog connection). There are discs which audio cannot be changed because of how the disc was created. 	– 44 12, 44 –

DVD Play		Page
Play fails to start even when [▶], [PLAY] is pressed. Play starts but then stops immediately.	<ul style="list-style-type: none"> Insert the disc correctly with the label facing up. You tried to play a blank DVD-RAM/DVD-R, or discs unplayable on this unit. When recording to DVD-RAM using EP (8H) mode, play may not be possible on DVD players that are compatible with DVD-RAM. In this case use EP (6H) mode. 	20 19 43
DVD-Video is not played.	<ul style="list-style-type: none"> Some DVD-Video cannot be played when you change the ratings level. 	43
Alternative sound track and subtitles cannot be selected.	<ul style="list-style-type: none"> The languages are not recorded on the disc. You may have to use the disc's own menus to select languages. 	– –
No subtitles.	<ul style="list-style-type: none"> When progressive output is on, closed captions cannot be displayed. Subtitles are not recorded on the disc. Turn the Subtitles ON. 	– – 40
Angle cannot be changed.	<ul style="list-style-type: none"> This function depends on software availability. Angles can only be changed during scenes where different angles are recorded. 	–
You have forgotten your ratings password.	<ul style="list-style-type: none"> With the tray open, keep pressing [◀◀/▶▶] and [▶▶/▶▶] on the main unit simultaneously for 5 or more seconds. 	–
Quick View does not work.	<ul style="list-style-type: none"> This does not work if the setting is "Off" in "Search Audio & PLAY X1.3". This does not work when audio is other than Dolby Digital. This does not work when recording is in XP or FR mode. 	44 – –
The resume play function does not work.	<ul style="list-style-type: none"> This function only works when "PB" is flashing in the unit's display. Memorized positions are canceled when the unit is turned off or when the tray is opened. The memorized position on the play list is also canceled when the play list and title are edited. 	21 –

Helpful Hints



DVD Recording, timer recording

		Page
Cannot record.	• You haven't inserted a disc or the disc you inserted cannot be recorded on. Insert a disc the unit can record onto.	19
	• The disc is unformatted. Format the disc. RAM	31
	• The write-protect tab on the cartridge is set to "PROTECT" or the disc is protected with "DISC SETTING".	18, 30
	• Some programs have limitations on the number of times they can be recorded (CPRM).	18, 63
	• The disc is full or nearly full. Erase unneeded titles or use another disc.	23, 33, 37
	• You cannot record on finalized DVD-R discs.	18
	• If you repeatedly insert discs or turn this unit on and off 50 times or more, the recording or editing of DVD-R may be disabled.	-
	• The material you are trying to record is copy-guarded.	-
A part or whole of a recorded title has been lost.	• Timer recording will not be activated when in editing or transfer (dubbing). Timer recording will begin after the editing/transfer (dubbing) is finished.	-
	• If the power shuts down or the plug is disconnected from the household AC outlet while recording or editing, the program may be lost or the disc may become unusable. → We cannot offer any guarantee regarding lost titles or discs. You will have to format the disc (RAM) or use a new disc.	-

DVD Edit

		Page
Cannot format.	• The disc is dirty. Use a special cleaner and wipe clean.	19
	• You tried formatting a disc that is not compatible with this unit.	19
Cannot create chapters. Cannot mark the start point or the end point during "Shorten" operation.	• The unit writes the chapter division information to the disc when you turn it off or remove the disc. The information is not written if there is an interruption in the power before this.	-
	• These operations are not possible with still pictures.	-
	• You cannot set points if they are too close to each other. You cannot set an end point before a start point.	-
Cannot erase chapters.	• When the chapter is too short to erase, use "Combine Chapters" to make the chapter longer.	35
The available recording time doesn't increase even after erasing recordings on the disc.	• Available recording space on the DVD-R does not increase even after erasing previously recorded titles.	-
Cannot create a play list.	• You cannot select all the chapters at once in a title if the title also includes still pictures. Select them individually.	-

■ VHS

VHS Picture

		Page
OSD messages do not appear.	• Go to VHS MENU and select "ON" in "OSD". Press [STATUS] to show the on-screen messages constantly.	56 57
	• You are playing a blank or poor quality part of the tape.	-
The blue back appears during play.	• You can damage the unit if you play dirty or damaged tapes and this can cause the blue back to appear. Consult your dealer.	-

VHS Sound

		Page
Cannot hear the desired audio type.	• Press [AUDIO] to select the audio.	57
There is noise when playing a video tape.	• Adjust the tracking.	50
	• The tape is old or damaged.	-

VHS Play

		Page
Cannot play.	• Tapes recorded under a TV system other than NTSC (PAL, SECAM, etc.) cannot be played.	-
The playback screen flickers.	• The video head is dirty.	-
	• The tape is too old or damaged.	-

VHS Recording, timer recording

		Page
"  " flashes when I try to start recording. Cannot record.	• The erasure prevention tab has been removed. Cover the hole with adhesive tape.	48
Cannot record TV program.	• The desired channel is not selected. Select the desired TV program.	-

Product Service

- 1. Damage requiring service** — The unit should be serviced by qualified service personnel if:
 - (a) The AC power supply cord or AC adaptor has been damaged; or
 - (b) Objects or liquids have gotten into the unit; or
 - (c) The unit has been exposed to rain; or
 - (d) The unit does not operate normally or exhibits a marked change in performance; or
 - (e) The unit has been dropped or the cabinet damaged.
- 2. Servicing** — Do not attempt to service the unit beyond that described in these operating instructions. Refer all other servicing to authorized servicing personnel.
- 3. Replacement parts** — When parts need replacing ensure the servicer uses parts specified by the manufacturer or parts that have the same characteristics as the original parts. Unauthorized substitutes may result in fire, electric shock, or other hazards.
- 4. Safety check** — After repairs or service, ask the servicer to perform safety checks to confirm that the unit is in proper working condition.

■ Product information

For product information or assistance with product operation:

In the U.S.A., refer to "Customer Services Directory" on page 71.

In Canada, contact the Panasonic Canada Inc. Customer Care Centre at 1-800-561-5505, or visit the website (www.panasonic.ca), or an authorized Servicentre closest to you.

The model number and serial number of this product can be found on either the back or the bottom of the unit. Please note them in the space provided below and keep for future reference.

MODEL NUMBER _____ DMR-E75V _____
SERIAL NUMBER _____

User memo:

DATE OF PURCHASE _____
DEALER NAME _____
DEALER ADDRESS _____
TELEPHONE NUMBER _____

Limited Warranty (ONLY FOR U.S.A.)

**Panasonic Consumer Electronics Company,
Division of Matsushita Electric Corporation of America**
One Panasonic Way Secaucus, New Jersey 07094

**Panasonic Sales Company, Division of Matsushita Electric
of Puerto Rico, Inc.,**
Ave. 65 de Infantería, Km. 9.5
San Gabriel Industrial Park, Carolina, Puerto Rico 00985

Panasonic DVD Recorder Limited Warranty

Limited Warranty Coverage

If your product does not work properly because of a defect in materials or workmanship, Panasonic Consumer Electronics Company or Panasonic Sales Company (collectively referred to as "the warrantor") will, for the length of the period indicated on the chart below, which starts with the date of original purchase ("warranty period"), at its option either (a) repair your product with new or refurbished parts, or (b) replace it with a new or a refurbished product. The decision to repair or replace will be made by the warrantor.

Product or Part Name	Parts	Labor
DVD Recorder	One (1) Year	One (1) Year
Rechargeable Batteries, DVD-RAM Disc (in exchange for defective item)	Ten (10) Days	Not Applicable

During the "Labor" warranty period there will be no charge for labor. During the "Parts" warranty period, there will be no charge for parts. You must carry-in or mail-in your product during the warranty period. If non-rechargeable batteries are included, they are not warranted. This warranty only applies to products purchased and serviced in the United States or Puerto Rico. This warranty is extended only to the original purchaser of a new product which was not sold "as is". A purchase receipt or other proof of the original purchase date is required for warranty service.

Carry-In or Mail-In Service

For Carry-In or Mail-In Service in the United States call 1-800-211-PANA (7262) or visit Panasonic Web Site: <http://www.panasonic.com>
For assistance in Puerto Rico call Panasonic Sales Company (787)-750-4300 or fax (787)-768-2910.

Limited Warranty Limits And Exclusions

This warranty ONLY COVERS failures due to defects in materials or workmanship, and DOES NOT COVER normal wear and tear or cosmetic damage. The warranty ALSO DOES NOT COVER damages which occurred in shipment, or failures which are caused by products not supplied by the warrantor, or failures which result from accidents, misuse, abuse, neglect, mishandling, misapplication, alteration, faulty installation, set-up adjustments, misadjustment of consumer controls, improper maintenance, power line surge, lightning damage, modification, or commercial use (such as in a hotel, office, restaurant, or other business), rental use of the product, service by anyone other than a Factory Servicenter or other Authorized Servicer, or damage that is attributable to acts of God.

THERE ARE NO EXPRESS WARRANTIES EXCEPT AS LISTED UNDER "LIMITED WARRANTY COVERAGE". THE WARRANTOR IS NOT LIABLE FOR INCIDENTAL OR CONSEQUENTIAL DAMAGES RESULTING FROM THE USE OF THIS PRODUCT, OR ARISING OUT OF ANY BREACH OF THIS WARRANTY. (As examples, this excludes damages for lost time, travel to and from the servicer, loss of media or images, data or other recorded content. The items listed are not exclusive, but are for illustration only.) **ALL EXPRESS AND IMPLIED WARRANTIES, INCLUDING THE WARRANTY OF MERCHANTABILITY, ARE LIMITED TO THE PERIOD OF THE LIMITED WARRANTY.**

Some states do not allow the exclusion or limitation of incidental or consequential damages, or limitations on how long an implied warranty lasts, so the exclusions may not apply to you.

This warranty gives you specific legal rights and you may also have other rights which vary from state to state. If a problem with this product develops during or after the warranty period, you may contact your dealer or Servicenter. If the problem is not handled to your satisfaction, then write to the warrantor's Consumer Affairs Department at the addresses listed for the warrantor.

PARTS AND SERVICE WHICH ARE NOT COVERED BY THIS LIMITED WARRANTY ARE YOUR RESPONSIBILITY.

Customer Services Directory

Obtain Product Information and Operating Assistance; locate your nearest Dealer or Servicenter; purchase Parts and Accessories; or make Customer Service and Literature requests by visiting our Web Site at:

<http://www.panasonic.com/support>

or, contact us via the web at:

<http://www.panasonic.com/contactinfo>

You may also contact us directly at:

1-800-211-PANA (7262),

Monday-Friday 9 am-9 pm; Saturday-Sunday 10 am-7 pm, EST.

For hearing or speech impaired TTY users, TTY : 1-877-833-8855

Accessory Purchases

Purchase Parts, Accessories and Instruction Books online for all Panasonic Products by visiting our Web Site at:

<http://www.pasc.panasonic.com>

or, send your request by E-mail to:

npcparts@panasonic.com

You may also contact us directly at:

1-800-332-5368 (Phone) 1-800-237-9080 (Fax Only) (Monday – Friday 9 am to 8 pm, EST.)

Panasonic Services Company

20421 84th Avenue South, Kent, WA 98032

(We Accept Visa, MasterCard, Discover Card, American Express, and Personal Checks)

For hearing or speech impaired TTY users, TTY : 1-866-605-1277

Service in Puerto Rico

Matsushita Electric of Puerto Rico, Inc. Panasonic Sales Company

Factory Servicenter:

Ave. 65 de Infantería, Km. 9.5, San Gabriel Industrial Park, Carolina, Puerto Rico 00985

Phone (787)750-4300, Fax (787)768-2910

Limited Warranty (ONLY FOR CANADA)

Panasonic Canada Inc.
5770 Ambler Drive, Mississauga, Ontario L4W 2T3

PANASONIC/TECHNICS PRODUCT—LIMITED WARRANTY

Panasonic Canada Inc. warrants this product to be free from defects in material and workmanship and agrees to remedy any such defect for a period as stated below from the date of original purchase.

Panasonic DVD Recorder One (1) year, parts and labour

LIMITATIONS AND EXCLUSIONS

This warranty does not apply to products purchased outside Canada or to any product which has been improperly installed, subjected to usage for which the product was not designed, misused or abused, damaged during shipping, or which has been altered or repaired in any way that affects the reliability or detracts from the performance, nor does it cover any product which is used commercially. Dry cell batteries are also excluded from coverage under this warranty.

This warranty is extended to the original end user purchaser only. A purchase receipt or other proof of date of original purchase is required before warranty service is performed.

THIS EXPRESS, LIMITED WARRANTY IS IN LIEU OF ALL OTHER WARRANTIES, EXPRESS OR IMPLIED, EXCLUDING ANY IMPLIED WARRANTIES OF MERCHANTABILITY OR FITNESS FOR A PARTICULAR PURPOSE.

IN NO EVENT WILL PANASONIC CANADA INC. BE LIABLE FOR ANY SPECIAL, INDIRECT OR CONSEQUENTIAL DAMAGES.

In certain instances, some jurisdictions do not allow the exclusion or limitation of incidental or consequential damages, or the exclusion of implied warranties, so the above limitations and exclusions may not be applicable.

WARRANTY SERVICE

For product operation and information assistance, please contact your Dealer or our Customer Care Centre at:

Telephone #: (905) 624-5505 Fax #: (905) 238-2360 Web: www.panasonic.ca

For product repairs, please contact one of the following:

- Your Dealer who will inform you of an authorized Servicentre nearest you.
- Our Customer Care Centre at (905) 624-5505 or www.panasonic.ca
- A Panasonic Factory Servicentre listed below:

Richmond,

British Columbia

Panasonic Canada Inc.
12111 Riverside Way
Richmond, BC
V6W 1K8
Tel: (604) 278-4211
Fax: (604) 278-5627

Calgary, Alberta

Panasonic Canada Inc.
6835-8th St. N. E.
Calgary, AB
T2E 7H7
Tel: (403) 295-3955
Fax: (403) 274-5493

Mississauga, Ontario

Panasonic Canada Inc.
5770 Ambler Dr.
Mississauga, ON
L4W 2T3
Tel: (905) 624-8447
Fax: (905) 238-2418

Lachine, Québec

Panasonic Canada Inc.
3075, rue Louis A. Amos
Lachine, QC
H8T 1C4
Tel: (514) 633-8684
Fax: (514) 633-8020

IF YOU SHIP THE PRODUCT TO A SERVICENTRE

Carefully pack and send prepaid, adequately insured and preferably in the original carton.
Include details of the defect claimed, and proof of date of original purchase.

Specifications

Power Supply:	AC 120 V \pm 10% , 50/60 Hz \pm 10%
Power Consumption:	32 W (Approx. 2 W in power save mode)

DVD

Recording format:	DVD-RAM: DVD Video Recording format DVD-R: DVD Video format Audio: Dolby Digital 2 CH
Optical pickup	System with 1 lens, 2 integration units (wavelength: 658 nm for DVD, 795 nm for CD)
Recording disc:	DVD-RAM: 12 cm (5") 4.7 GB, 12 cm (5") 9.4 GB, 8 cm (3") 2.8 GB DVD-R: 12 cm (5") 4.7 GB, 8 cm (3") 1.4 GB (for General Ver. 2.0) 12 cm (5") 4.7 GB (for General Ver. 2.0/4 \times -SPEED DVD-R Revision 1.0)
Recording mode/ recording time:	XP: approx. 10 Mbps/ approx. 60 min SP: approx. 5 Mbps/ approx. 120 min LP: approx. 2.5 Mbps/ approx. 240 min EP: approx. 1.7/1.2 Mbps/ approx. 360/480 min (with 4.7 GB disc)
Playable discs:	DVD-RAM: 12 cm (5") 4.7 GB, 12 cm (5") 9.4 GB, 8 cm (3") 2.8 GB DVD-R: 12 cm (5") 4.7 GB, 8 cm (3") 1.4 GB (for General Ver. 2.0) 12 cm (5") 4.7 GB (for General Ver. 2.0/4 \times -SPEED DVD-R Revision 1.0) DVD-Video, DVD-Audio, Video CD, CD-Audio (CD-DA), CD-R/RW (MP3, CD-DA, Video CD formatted discs)
Video interface	
Output:	
RCA:	CVBS: 1 Vp-p Zout: 75 ohm
S-Video:	Y: 1 Vp-p, C: 0.286 Vp-p Zout: 75 ohm
RCA (YPbPr):	Y: 1 Vp-p, Pb: 0.7 Vp-p, Pr: 0.7 Vp-p Zout: 75 ohm
Audio interface	
Input:	
L1:	
RCA:	Standard: 309 mVrms, FS: 2 Vrms at 1 kHz Zin: 22 k Ω
L2:	
RCA:	Standard: 309 mVrms, FS: 2 Vrms at 1 kHz Zin: 22 k Ω
Output:	
RCA:	Standard: 309 mVrms, FS: 2 Vrms at 1 kHz Zout: less than 1 k Ω
Digital Audio:	Optical Output connector (PCM, Dolby Digital, DTS)
Video data:	
Horizontal resolution:	More than XP: 500 lines SP: 400 lines LP: 200 lines EP: 200 lines
Signal to Noise Ratio:	More than 45 dB
Frequency Response:	XP, SP: 0 \pm 3 dB at 4 MHz (0 dB at 0.1 MHz), (Fine mode) LP, EP: 0 \pm 3 dB at 2 MHz (0 dB at 0.1 MHz), (Fine mode)
Audio data:	
Dynamic Range:	Rec/PB: more than 90 dB DVD-Video PB (with LPCM): more than 99 dB CD PB: more than 97 dB
Frequency Response:	XP, SP, LP, EP (6H mode): 20 Hz–20 kHz (0 \pm 3 dB) EP (8H mode): 20 Hz–12 kHz (0 \pm 3 dB)
Cross Talk:	More than 60 dB at 1 kHz

LASER Specification

Class 1 LASER Product	
Wave Length:	795 nm, 658 nm
Laser Power:	No hazardous radiation is emitted with safety protection

VHS

Recording format:	VHS Video Cassette System Standard with FM audio
Heads:	4 helical scan heads for video 2 helical scan heads for FM audio 1 fixed head for Normal audio
Recording modes/ recording time:	NTSC SP: 33.35 mm/s, 120 min NTSC EP: 11.12 mm/s, 360 min (with T-120 cassette) FF/REW: approx. 54 s, Jet REW: approx. 36 s (with T-120 cassette)
others:	
Audio interface	
Input:	
L1:	
RCA:	309 mVrms Zin: 22 k Ω
L2:	
RCA:	309 mVrms Zin: 22 k Ω
Video data:	
Horizontal resolution:	More than 200 lines
Signal to Noise Ratio:	More than SP: 40 dB EP: 40 dB
Frequency Response:	SP, EP: -4.5–4.0 dB at 2 MHz (0 dB at 0.1 MHz)
Audio data:	
Dynamic Range:	Hi-Fi: more than 90 dB
Frequency Response:	Hi-Fi: 20 Hz–20 kHz (0 \pm 3 dB) Normal SP: 80 Hz–8 kHz (0 \pm 4 dB) Normal EP: 80 Hz–4 kHz (-1 \pm 5 dB)
Signal to Noise Ratio:	Hi-Fi: more than 65 dB Normal SP: more than 43 dB Normal EP: more than 41 dB
Cross Talk:	More than 50 dB at 1 kHz (Hi-Fi)
Wow and Flutter:	Hi-Fi: less than 0.005% Normal SP: 0.2% max Normal EP: 0.4% max

DVD/VHS Common

Video interface:	NTSC
TV system:	NTSC
Input:	
L1:	
RCA:	CVBS: 1 Vp-p Zin: 75 ohm
S-Video:	Y: 1 Vp-p, C: 0.286 Vp-p Zin: 75 ohm
L2:	
RCA:	CVBS: 1 Vp-p Zin: 75 ohm
S-Video:	Y: 1 Vp-p, C: 0.286 Vp-p Zin: 75 ohm
Output:	
RCA:	CVBS: 1 Vp-p Zout: 75 ohm
Audio interface:	
Output:	
RCA:	
DVD:	Standard: 309 mVrms, FS: 2 Vrms at 1 kHz Zout: less than 1 k Ω
VHS	309 mVrms Zout: less than 1 k Ω
Tuner RF:	
Tuner system/ Channel coverage:	NTSC-M VHF: 2 ch–13 ch 75 ohm UHF: 14 ch–69 ch 75 ohm CATV: 5A & A-5 ch–EEE ch 75 ohm One tuner (DVD and VCR common use)
RF converter:	Not provided
Dimensions:	Approx. 430 mm (W) \times 89 mm (H) \times 352 mm (D) [Approx. 16 ¹⁵ / ₁₆ " (W) \times 3 ¹ / ₂ " (H) \times 13 ⁷ / ₈ " (D)]
Mass:	Approx. 5.8 kg (12.79 lbs.)
Operating Temperature:	5°C–40°C (41°F–104°F)
Operating Humidity:	35%–80% RH (no condensation)

Note

Mass and dimensions shown are approximate.
Specifications are subject to change without notice.

Helpful Hints

Index

COMMON

Antenna System	14
Channel	
adding, deleting	14
audio (DVD)	40
Auto Channel Setting	14
captions	16
guide channel VCR Plus+ system	15
Cleaning	
disc, lens, main unit	19
video heads	48
Clock setting	46
Connection	
amplifier, system component	12
antenna	11
antenna, television	9, 10
cable TV box/satellite receiver	11
external device	62
TV Type	17
VCR Plus+ system	
guide channel	15
timer recording (DVD)	28
timer recording (VHS)	52

DVD

Angle	40
Audio	
attributes	40
playback	23
receiving, recording	27
Change Thumbnail	34
Chasing play	25
CM Skip	22
Copy (play list)	38
CPRM system	18, 63
Create chapters	23
Create play lists	36
Dialog Enhancer	41
Direct Navigator	33, 54
Display menus	40
DVD-RAM, DVD-R	18
Enter Name	
disc	30
operation	32
play list	38
title	28, 34
Erase	
chapter	35
chapter in play list	39
play list	37
title	23, 33
Finalize	31, 63
Flexible Recording	27
Format disc	31
FUNCTIONS window	47
Language	
audio	43
code list	45
on-screen	45
sound track	40
subtitle	40, 43
Manual Transfer (Dubbing)	59
MP3	24
MPEG-DNR	41
One Touch Transfer (Dubbing)	58
PCM Down Conversion	44
Picture	41
Play list	36
Progressive	17, 41, 63
Properties	

play list	37
title	33
Protection	
cartridge	18
disc	30
title	34
Quick View	21
Ratings	42, 43
Re-initialize Settings	43
Recording modes	27
Repeat play	41
Resume function	21
SETUP menu	42
Shorten (titles)	34
Simultaneous recording and play	25
Sound track	40
Status displays	47
Subtitle	40, 43
Time Slip	23, 25
Timer recording	28
Transfer	41
TV Type	17
V.S.S.	41

VHS

Audio	57
Auto Bilingual Choice	57
Auto SP/EP mode	53
Category	55
Direct Navigator	54
Intact erasure prevention tab	48
Jet Rewind	49
Manual Transfer (Dubbing)	61
On-screen display	57
One Touch Transfer (Dubbing)	60
Remaining tape time	57
Repeat Playback	50
SQPB	50
Time Stamp	55
Timer recording	52
Tracking	50
VHS menu	56
VISS	55
VP mode	51

Antes de uso

- Las conexiones del equipo descritas sirven en concepto de ejemplo.
- Antes de conectar, apague todo equipo y lea las instrucciones correspondientes de funcionamiento.
- Los equipos periféricos y los cables correspondientes y los cables opcionales se venden por separado si no está indicado de otro modo.

■ Conexión a un televisor o a un VCR

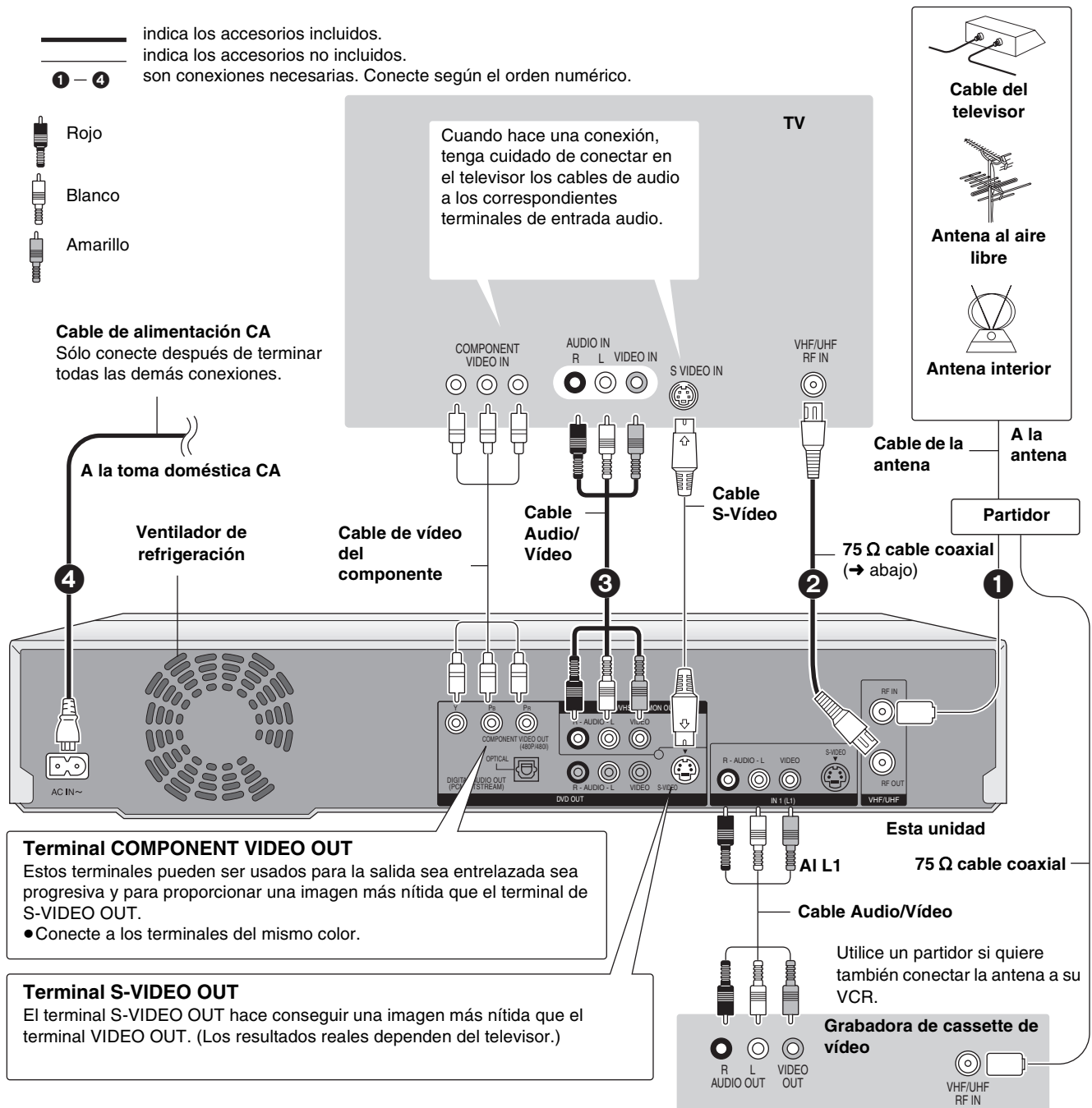

■ 75 Ω cable coaxial

- La imagen y el sonido desde esta unidad no pasa a través del cable coaxial 75 Ω al televisor. Tenga cuidado de conectar uno de los siguientes terminales en esta unidad al televisor: el terminal AUDIO/VIDEO OUT, el terminal S-VIDEO OUT o el terminal COMPONENT VIDEO OUT. Si el televisor no tiene ninguno de estos terminales, consulte a su proveedor local.

■ Cuando la unidad no ha de ser usada durante un largo tiempo

Para ahorrar energía, desenchúfela de la toma doméstica CA. Esta unidad consume una pequeña cantidad de corriente aun cuando está apagada (aproximadamente 2 W).

■ No conecte la unidad a través de la grabadora del cassette de vídeo

Las señales de vídeo alimentadas a través de las grabadoras de cassette de vídeo se afectarán por los sistemas de protección de los derechos de autor y la imagen no se verá correctamente en el televisor.

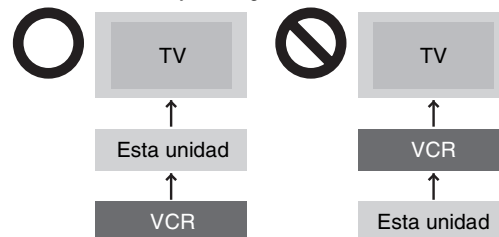

- Cuando se conecte a un televisor teniendo un VCR incorporado, conéctelo a los terminales de entrada por el lado del televisor y no por el lado del VCR.

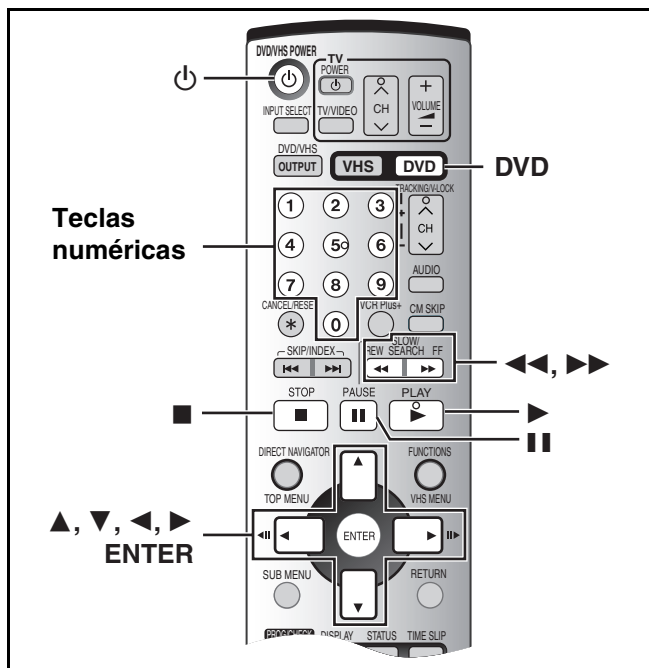

Ajustes del canal de guía para el sistema VCR Plus+

Ajuste estos canales de guía de manera que se pueda usar el sistema VCR Plus+ para la grabación temporizada. Antes de proceder a los ajustes, prepare el papel que muestra los canales, los nombres de las estaciones y los canales de guía.

por ej.,

Nombre de la estación	Canal de guía*	Número del canal**	Ajuste del canal (En el paso 5)
CBS	04	04	Innecesario
HBO	33	15	Introduzca el canal 15 sucesivo al canal de guía 33.
Nickelodeon	38	20	Introduzca el canal 20 sucesivo al canal de guía 38.

* Mire en los canales de guía para las estaciones en revistas.

** Apunte todas las estaciones que puede recibir.

• Si ha conectado una caja TV de cable o un receptor de satélite, el sistema VCR Plus+ no funciona como no ha ajustado los canales de la guía.

Operaciones preliminares

• Pulse [DVD].

- Mientras el disco está detenido Pulse [FUNCTIONS].
- Seleccione "SETUP" con [▲, ▼, ◀, ▶] y pulse [ENTER].
- Seleccione "Canal" con [▲, ▼] y pulse [◀, ▶].
- Seleccione "VCR Plus+ Ajuste canal" con [▲, ▼], luego pulse [ENTER].
- Utilice [▲, ▼] para seleccionar el canal de guía que quiere ajustar y pulse [▶].
- Utilice [▲, ▼] para seleccionar el canal correspondiente al de guía y pulse [◀].
 - Para borrar un número, pulse [CANCEL/RESET, *].
 - Repita los pasos 5 y 6 para introducir otros canales.
- Pulse [ENTER].

Selección del tipo de televisor

No debe cambiar el ajuste cuando está conectado a un televisor que tiene el aspecto estándar de 4:3 y no es compatible con la salida progresiva.

Operaciones preliminares

• Pulse [DVD].

- Mientras el disco está detenido Pulse [FUNCTIONS].
- Seleccione "SETUP" con [▲, ▼, ◀, ▶] y pulse [ENTER].
- Seleccione "Pantalla TV" con [▲, ▼] y pulse [◀, ▶].
- Seleccione "Tipo TV" con [▲, ▼] y pulse [ENTER].
 - Aspecto 4:3/Aspecto 16:9:

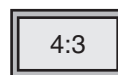

Televisor de aspecto estándar 4:3

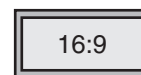

Televisor de pantalla panorámica 16:9

• 480P/480i:
Seleccione "480P" si el televisor es compatible con la salida progresiva.

- Utilice [▲, ▼] para seleccionar el detalle, luego pulse [ENTER].

Sintonización automática por enchufe

Operaciones preliminares

- Encienda el televisor y seleccione la entrada de vídeo correspondiente para conformar las conexiones a esta unidad.
- Si conecta la unidad a una caja de televisor de cable o a un receptor de satélite, sintonice su PBS local para que funcione el "Ajuste automático del reloj". Si no hay PBS local, ajuste el reloj manualmente ("Ajuste manual del reloj").
- Pulse [DVD].

- Pulse [⏻, DVD/VHS POWER].

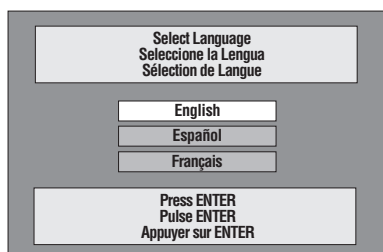

- Utilice [▲, ▼] para seleccionar el idioma del menú y oprima [ENTER].
- Oprima [ENTER] para iniciar la sintonización automática por enchufe. Luego, la unidad procede al ajuste automático del reloj. El temporizador se visualiza cuando finaliza.
- Pulse [ENTER].

■ Si el reloj adelanta o atrasa una hora respecto a la hora actual

- Mientras el disco está detenido, pulse [FUNCTIONS].
- Seleccione "SETUP" con [▲, ▼, ◀, ▶] y pulse [ENTER].
- Ajuste "-1" o "+1" en "Ajuste del huso horario" en el menú "Configuración" usando [▲, ▼, ◀, ▶] y [ENTER].
- Pulse [RETURN] para salir.

■ Si la unidad no puede ajustar automáticamente el reloj Pulse [ENTER] para visualizar la pantalla "Ajuste manual del reloj". Ajuste la hora manualmente.

■ Para volver a la pantalla anterior

Pulse [RETURN].

■ Para salir de la pantalla

Pulse [RETURN].

Introducción de discos

1 Pulse [▲, OPEN/CLOSE] en la unidad principal para abrir la bandeja.

Puede Ud. insertar un disco de cartucho o sin cartucho.

2 Pulse [▲OPEN/CLOSE] en la unidad principal para cerrar la bandeja.

- Al introducir un DVD-RAM con la lengüeta de protección de escritura ajuste a "PROTECT (PROTEGER)", la reproducción comienza automáticamente.

Nota

- Cargue los discos de dos caras de manera que la etiqueta de la cara que quiere grabar/reproducir mire hacia arriba.
- No es posible grabar continuamente de un lado de un disco de doble cara al otro. Es necesario que se expulse el disco y se lo revuelva.
- Cuando utiliza un DVD-RAM de 8 cm (3"), quite el disco del cartucho e insértelo, teniendo cuidado de alinearlos con la ranura.

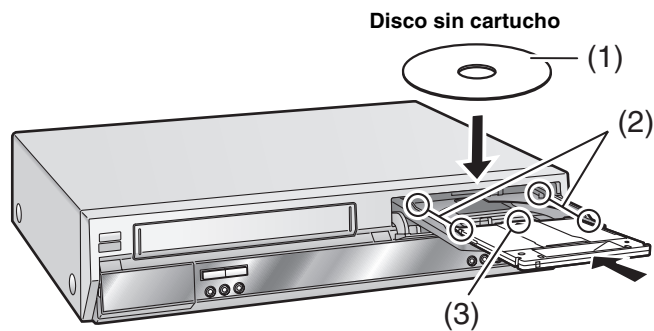

- (1) Inserte etiqueta arriba.
 (2) Insertar el disco en la parte inferior de las guías de la bandeja.
 (3) Insertar el disco con la etiqueta hacia arriba y la flecha hacia el interior.

Reproducción de los discos

RAM DVD-R DVD-A DVD-V VCD CD MP3

Operaciones preliminares

- Pulse [DVD].

1 Pulse [⏻, DVD/VHS POWER] para encender la unidad.

2 Inserte un disco. (→ arriba)

3 Pulse [▶, PLAY].

La bandeja se cierra y comienza la reproducción.

(La unidad emplea un tiempo para la adquisición de los datos del disco antes de comenzar la reproducción.)

- La reproducción inicia desde el último título grabado.

RAM DVD-R

- La reproducción inicia a partir del comienzo del disco.

DVD-A DVD-V VCD CD MP3

■ Para detener la reproducción

Pulse [■, STOP]. (→derecha, "Función Resume")

- Cuando se detiene la reproducción es posible que aparezca una pantalla como a la derecha. Pulsando otra vez [■, STOP] es posible utilizar el sintonizador de la unidad para ver la televisión.



DVD-A DVD-V VCD CD MP3

■ Para interrumpir provisionalmente la reproducción

Pulse [⏸, PAUSE]. (Pulse nuevamente la tecla para reanudar la reproducción.)

■ Cuando en el televisor aparece la pantalla de un menú

VCD

Pulse las teclas numéricas para seleccionar un detalle.

por ej.: "5": [0]→[5]

"15": [1]→[5]

DVD-A DVD-V

Pulse [▲, ▼, ◀, ▶] para seleccionar un detalle, luego pulse [ENTER].

- Para seleccionar un detalle es posible también utilizar las teclas numéricas.

Otros botones usados para hacer funcionar los menús

Lea las instrucciones del disco para más información acerca del funcionamiento.

Nota

- Si aparece "⊘" en el televisor, la unidad o el disco prohíben la operación.

Vista rápida (Reproducción ×1.3)

RAM (Solo con Dolby Digital)

Puede ser aumentada la velocidad de reproducción sin distorsionar el audio.



Durante la reproducción

Pulse y mantenga [▶, PLAY].

■ Para volver a la velocidad normal

Pulse [▶, PLAY].

Continuación de la reproducción (Función Resume)

RAM DVD-R DVD-A DVD-V CD VCD MP3

1 Durante la reproducción

Pulse [■, STOP].

- "PB" destella en el visualizador de la unidad (solo reproducción normal). La unidad memoriza la posición.

por ejemplo:
Reproducción normal

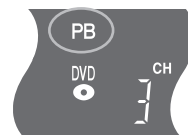

2 Pulse [▶, PLAY].

- La reproducción vuelve a comenzar de donde se interrumpió.

■ Para cancelar la función de reanudación (solo reproducción normal)

Pulse [■, STOP] mientras la unidad recuerda la posición.

(La posición se borra también cuando se apaga la unidad.)



Avance rápido y rebobinado—SEARCH

RAM DVD-R DVD-A DVD-V CD VCD MP3

Durante la reproducción

Pulse [◀◀, SLOW/SEARCH] o [▶▶, SLOW/SEARCH].

- En la unidad principal, mantenga pulsado [◀◀/▶▶] o [▶▶/▶▶].

- Hay 5 velocidades de búsqueda. Cada vez que se pulsa la tecla la velocidad de búsqueda aumenta.
- Pulse [▶, PLAY] para volver a iniciar la reproducción.



Reproducción de cámara lenta

RAM DVD-R DVD-A (Sólo partes de imagen en movimiento) DVD-V VCD

Durante la pausa

Pulse [◀◀, SLOW/SEARCH] o [▶▶, SLOW/SEARCH].

- En la unidad principal, mantenga pulsado [◀◀/▶▶] o [▶▶/▶▶].
- Cuando la reproducción de movimiento lenta dura más de 5 minutos, se detiene automáticamente.

- La velocidad aumenta hasta 5 pasos.
- Pulse [▶, PLAY] para volver a iniciar la reproducción.
- Sólo dirección en avance ([▶▶], [▶▶/▶▶]). VCD

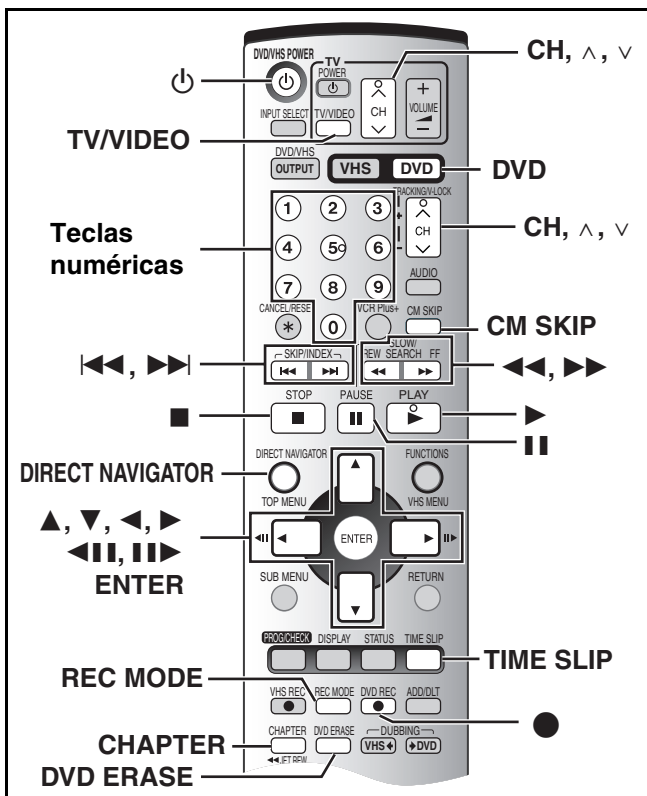

Operaciones preliminares

- Pulse [DVD].

Visión cuadro por cuadro

RAM DVD-R DVD-A DVD-V CD VCD

Durante la pausa

Pulse [**◀▶▶**], [**▶▶▶**], [**◀**] o [**▶**].

- Cada vez que se pulsa aparece el cuadro siguiente o el anterior.
- Pulse [**▶**, PLAY] para volver a iniciar la reproducción.
- Solo dirección en avance (**▶▶▶**, [**▶**]). **VCD**

Salto

RAM DVD-R DVD-A DVD-V CD VCD MP3

Durante la reproducción o la pausa

Pulse [**◀◀◀**, SKIP] o [**▶▶▶**, SKIP].

- En la unidad principal, pulse [**◀◀◀/◀◀**] o [**▶▶▶/▶▶**].

- Cada presión hace aumentar el número de saltos.

Reproducción directa

RAM DVD-R DVD-A DVD-V VCD CD MP3

Inicio de la reproducción desde un título, capítulo o una pista seleccionados.

Durante la reproducción

Pulse las teclas numéricas para seleccionar el detalle.

por ej.: "5": [0]→[5] **MP3** "5": [0]→[0]→[5]
"15": [1]→[5] "15": [0]→[1]→[5]

DVD-A

Salva pantalla

Mientras que está visualizado el salva pantalla puede ser especificado un número de grupo.

por ej.: "5": [5]

- Éste sólo funciona cuando está parada (está visualizado el salva pantalla) con algunos discos.

Reproducir grupos adicionales

Unos discos contienen grupos adicionales. Si aparece una pantalla de contraseña después de seleccionar un grupo, introduzca la contraseña con los botones numéricos, luego pulse [ENTER]. Se refiera también a la envoltura del disco.



Salto CM

RAM DVD-R

Puede saltar por cerca de 1 minuto por cada vez que se pulsa.

Durante la reproducción

Pulse [CM SKIP].

Visualización de la imagen TV como imagen en imagen/ Selección de la cantidad de tiempo a saltar—Time Slip

RAM DVD-R

Salta al tiempo especificado.

Visualiza la imagen TV a ser recibida como imagen en imagen.

1 Durante la reproducción

Pulse [TIME SLIP]. (Vuelva a pulsar para suprimir.)

- Escuchará el audio de la reproducción.
- El fondo azul no aparece en la pantalla de recepción.

2 Pulse [**▲**, **▼**] para introducir el tiempo y pulse [ENTER].

- El indicador del tiempo se apagará después de 5 segundos aproximadamente, pero ajustando de nuevo el indicador volverá a encenderse.
- La reproducción saltará el tiempo especificado.
- Pulse para cambiar por unidades de 1 minuto. Pulse y mantenga pulsado para cambiar por unidades de 10 minutos.

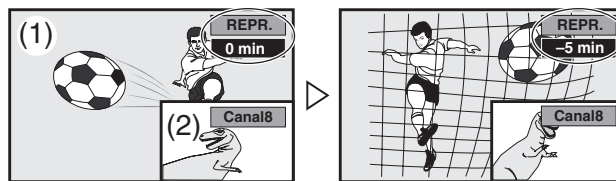

(1) Imágenes reproducidas

(2) Imágenes actuales en recepción

- Puede cambiar el canal a ser recibido pulsando [CH, ^, v].
- No puede cambiar el canal a ser recibido mientras va grabando.

Para visualizar completamente las imágenes de reproducción

Pulse [TIME SLIP].

Borrado de un título que se está reproduciendo

RAM DVD-R

Puede borrar los títulos mientras va reproduciendo.

- Una vez borrado el título no puede ser restablecido. Asegúrese antes de proceder.

1 Durante la reproducción

Pulse [DVD ERASE].

2 Seleccione "Borrar" con [**◀**] y pulse [ENTER].

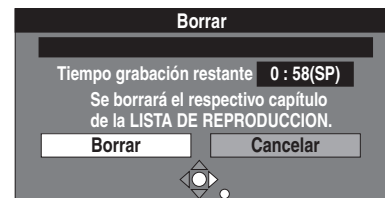

Crear capítulos

RAM

1 Durante la reproducción

Pulse [CHAPTER].

- Pulse [**◀◀**, SKIP] o [**▶▶**, SKIP] para saltar al comienzo del capítulo.
- No puede activar esta función cuando graba y reproduce al mismo tiempo.

Reproducción durante la grabación

RAM

Operaciones preliminares

- Pulse [DVD].

Sugerencia

- El sonido no funciona durante el avance rápido.

Reproducción seguida

Es posible empezar la reproducción desde el comienzo de un título mientras lo sigue grabando.

Durante la grabación o la grabación temporizada

Pulse [▶, PLAY].

Se enciende el indicador Time Slip en la unidad principal.

Grabación y reproducción simultáneas

Es posible comenzar la reproducción del título que se está grabando o reproducir un título grabado anteriormente.

Durante la grabación o la grabación temporizada

1 Pulse [DIRECT NAVIGATOR].

2 Utilice [▲, ▼, ◀, ▶] para seleccionar el título, luego pulse [ENTER].

- Se enciende el indicador Time Slip en la unidad principal.
- Para salir de la visión del título, pulse [DIRECT NAVIGATOR].

TIME SLIP

Es posible reproducir el título que se está grabando para controlar su correcta grabación. Es también posible controlar las partes grabadas anteriormente.

Durante la grabación o la grabación temporizada

1 Pulse [TIME SLIP].

2 Pulse [▲, ▼] para seleccionar el tiempo, luego pulse [ENTER].

- El indicador del tiempo se apagará después de 5 segundos aproximadamente, pero ajustando de nuevo el indicador volverá a encenderse.
- Pulse [▲, ▼] para cambiar por unidades de 1 minuto. Pulse y mantenga pulsado [▲, ▼] para cambiar por unidades de 10 minutos.

Para visualizar completamente las imágenes de reproducción

Pulse [TIME SLIP].

- Pulse [TIME SLIP] para volver a la pantalla de imagen a imagen.

Referencia

- Según la escena, la imagen de la pantalla pequeña puede resultar distorsionada o bien parpadear. Sin embargo, esto no afecta la imagen grabada.

Para detener la reproducción y la grabación

1 Pulse [■, STOP]. La reproducción se detiene.

(Espere 2 segundos o más)

2 Pulse [■, STOP]. La grabación se detiene.

- No es posible detener la grabación con [■, STOP] durante la grabación temporizada. Para detener la grabación temporizada pulse [■, STOP], luego [ENTER] dentro de 5 segundos.
 - Puede también seguir pulsando [■] en la unidad principal durante más de 3 segundos para detener la grabación temporizada.

Recepción de las transmisiones televisivas durante la grabación

1 Pulse [TV/VIDEO] para cambiar el modo de entrada en "TV".

2 Pulse [CH, ▲, ▼] del televisor para seleccionar los canales TV deseados.

Referencia

- Es posible hacerlo también si la unidad está efectuando una grabación temporizada.
- La grabación no se ve afectada.

Grabación de programas televisivos

RAM DVD-R

- Puede grabar hasta 99 títulos en un disco.
- DVD-RAM/DVD-R tiene restricciones en la grabación.
- La grabación tendrá lugar en un espacio abierto en el disco duro o en el disco. Los datos no se sobrescribirán.
- Si no se deja espacio en el disco de grabación, será necesario que se borren los títulos innecesarios (→ 78) o se utilice un nuevo disco.

Operaciones preliminares

- Quite la protección. **RAM**

- Pulse [DVD].

1 Pulse [⏻, DVD/VHS POWER] para encender la unidad.

2 Inserte un disco. (→ 77)

- Cuando con esta unidad utiliza un DVD-RAM por la primera vez, formateelo para garantizar una esmerada grabación.

3 Pulse [CH, ▲, ▼] para seleccionar el canal.

Para seleccionar con las teclas numéricas:

Modo TV (Ondas hertzianas)

por ej., "5": [0]→[5]

"15": [1]→[5]

Modo CATV (Cable)

por ej., "5": [0]→[0]→[5]

"15": [0]→[1]→[5]

"115": [1]→[1]→[5]

4 Pulse [REC MODE] para seleccionar el modo de grabación.

5 Pulse [●, DVD REC] para iniciar la grabación.

- No es posible cambiar de canal o el modo durante la grabación. Es posible cambiarlos cuando la grabación se encuentra en pausa, pero el material se grabará como un título separado.

Para detener temporalmente la grabación

Pulse [⏸, PAUSE]. (Pulse nuevamente la tecla para reanudar la grabación.)

- El título no puede dividirse en un título separado.

Para detener la grabación

Pulse [■, STOP].

- Grabado como 1 título hasta donde se detiene la posición.
- Después de terminar la grabación, el DVD-R lleva más o menos 30 segundos para que la unidad finalice su información de gestión.

Para especificar un tiempo para detener la grabación Durante la grabación

Pulse [●, DVD REC] para seleccionar el tiempo de grabación.

- En la unidad principal, pulse [●, REC].

Visualización de la unidad

Cada vez que pulsa la tecla:

Contador (suprimir) → 0:30 → 1:00 → 1:30

↑ 4:00 ← 3:00 ← 2:00 ←

Modos de grabación y tiempo aproximado de grabación

Según el contenido a ser grabado, los tiempos de grabación pueden salir más cortos que los señalados.

(Unidad: hora)

	DVD-RAM		DVD-R (4,7 GB)
	De un solo lado (4,7 GB)	Doble lado (9,4 GB)	
XP (Alta calidad)	1	2	1
SP (Normal)	2	4	2
LP (Larga duración)	4	8	4
EP (Reproducción de muy larga duración)	8 (6*)	16 (12*)	8 (6*)

* Cuando en el menú SETUP se ha ajustado a "EP (6H)" el "Tiempo de grab. en el modo EP".

La calidad del sonido se baja, en comparación con otros modos de grabación, cuando se usa "EP (8H)".

Nota

Cuando se graba en DVD-RAM usando el modo EP (8H), la reproducción puede no ser posible en unidades DVD que sean compatibles con DVD-RAM. En este caso utilice el modo EP (6H).

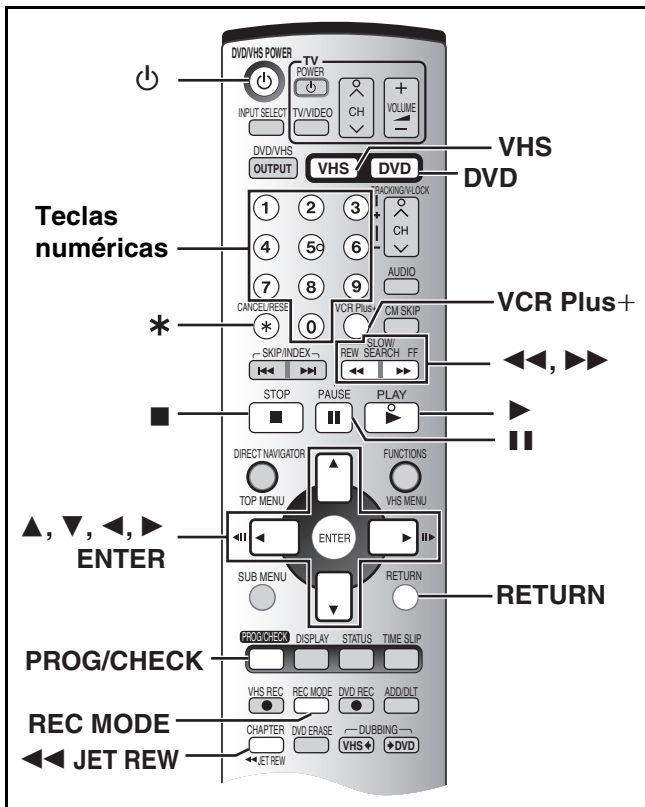

RAM DVD-R

Precauciones en la grabación temporizada

Cuando llega el tiempo que se definió, la grabación temporizada inicia automáticamente.

- La grabación temporizada puede iniciar mientras la unidad está tanto apagada como encendida. Cuando la unidad está apagada, el sonido y el vídeo no salen en el televisor.

Puede introducir hasta 16 programas con un adelanto de un mes.

Operaciones preliminares

- Quite la protección. **RAM**
- Inserte un disco (→ 77) y asegúrese de que haya bastante espacio vacío para grabarle encima.
- Pulse [DVD].

Uso del sistema VCR Plus+

- 1 Pulse [VCR Plus+].
- 2 Pulse las teclas numéricas para introducir el número PlusCode.
 - Pulse [◀] para volver a la cifra correcta.
- 3 Pulse [ENTER].
Cerciórese del programa y, si lo necesita, corrija usando [▲, ▼, ◀, ▶]. (→ abajo, paso 3)
- 4 Si el programa es correcto
Pulse [ENTER].
 - “⏻” se enciende en el visualizador de la unidad.
 - Repita los pasos 1-4 para programar otras grabaciones.
- 5 Pulse [RETURN].

Programación manual

- 1 Pulse [PROG/CHECK].
 - Cerciórese de que esté seleccionado “Nuevo programa”.
- 2 Pulse [ENTER].
- 3 Utilice [▶] para desplazar y cambiar los detalles con [▲, ▼].
 - Pueden usarse las teclas numéricas para introducir “CANAL”, “FECHA”, “ACT” y “DES”.
 - **CANAL** (Posición del programa/Nombre de la estación de TV)
 - **FECHA**
Puede crear usted un programa diario o semanal. Todos los programas diarios o semanales se cuentan como un solo programa.

- **ACT** (hora de encendido)/**DES** (hora final)
Si mantiene pulsado el botón, el tiempo aumentará o disminuirá en incrementos de 30 minutos.
- **MODO** (Modo de grabación)
Para cambiar el modo de grabación, puede pulsar también [REC MODE].
XP↔SP↔LP↔EP↔FR↔XP... (→ 79)

- **Intr.ir nomb.**
Pulse [◀, ▶] para seleccionar “Intr.ir nomb.” luego pulse [ENTER].

4 Al terminar las correcciones pulse [ENTER].

- “⏻” se enciende en el visualizador de la unidad.

- Para continuar programando:

Seleccione “Nuevo programa” y repita los pasos 2-4.

5 Pulse [RETURN].

Para detener la grabación mientras un programa está trabajando

Pulse [■, STOP], luego [ENTER] dentro de 5 segundos.

- Puede también seguir pulsando [■] en la unidad principal durante más de 3 segundos para detener la grabación.

Controle, cambie o borre el programa

1 Pulse [PROG/CHECK].

2 Pulse [▲, ▼] para seleccionar el programa.

- Puede seleccionarse el programa introduciendo un número de 2 cifras utilizando las teclas numéricas.

por ej.: “5”: [0]→[5]

“15”: [1]→[5]

- Utilice [◀, ▶] para desplazarse a la página que antecede o sigue la visualizada.

3 Pulse [CANCEL/RESET, *] para eliminar,

No es posible eliminar programas en fase de grabación.

o pulse [ENTER] para cambiar.

Se visualiza la pantalla de ajuste de la grabación temporizada.

4 Si pulsa [ENTER] en el paso 3,

Utilice [▲, ▼, ◀, ▶] para cambiar luego pulse [ENTER].

5 Pulse [RETURN].

Referencia

- Los programas cuya grabación no tuvo éxito no se borran inmediatamente de la lista (destacados en gris), pero se borran automáticamente a las 4 de la mañana dos días después.
- Durante la grabación temporizada puede cambiar el tiempo final mientras el modo de grabación no es “FR”.

Precauciones al usar la grabación temporizada en DVD y VHS

La grabación temporizada de programas TV no puede ejecutarse en DVD y VHS conjuntamente.

Verifique si el tiempo inicial de la grabación temporizada no se superpone en la pantalla de programación temporizada tanto del DVD (→ arriba) como del VHS (→ 83).

Cuando se superponen los ajustes de la grabación temporizada:

- Cuando el tiempo inicial de las dos grabaciones temporizadas es el mismo, la del DVD tiene la prioridad.
- Cuando están especificados los canales del sintonizador en la grabación temporizada tanto en el VHS como en el DVD, sólo podrá tener comienzo una grabación temporizada.
- Cuando el intervalo entre la primera grabación temporizada y la segunda en el DVD es de 1 minuto o menos como señalado a continuación, la segunda grabación temporizada en el DVD tiene la prioridad sobre la en el VHS aunque su tiempo inicial sea posterior a la grabación temporizada del VHS.

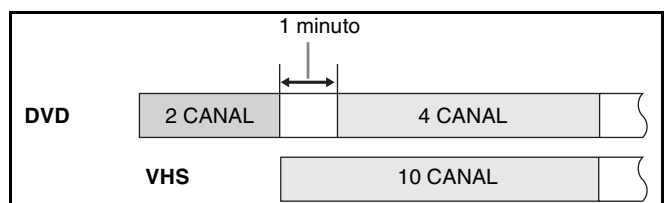

Introducción de un cassette de vídeo

Poniendo hacia arriba la superficie desde la que puede ver el rollo de la cinta,

Inserte un cassette de vídeo.

- Esta unidad se enciende automáticamente.

■ **Para expulsar el cassette de vídeo**

- Puede expulsar el cassette de vídeo cuando la unidad está en el modo de espera. Ésta vuelve en espera una vez que haya expulsado el cassette de vídeo.

Por lo que respecta a la unidad principal.

- Pulse [**▲**, EJECT] en la unidad principal.

Por lo que respecta al mando a distancia.

- Pulse [VHS], luego mantenga pulsado [■, STOP] durante 3 segundos o más.

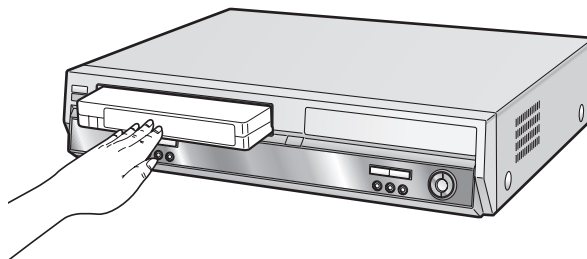

Cassette de vídeo

- Haga disparar la lengüeta del cassette de vídeo para evitar un borrado accidental. Cubra el orificio con una doble capa de cinta adhesiva para cuando quiere usar el cassette de vídeo para una nueva grabación.
- Puede usar los cassettes de vídeo con las marcas VHS y S-VHS, pero esta unidad no permite disfrutar plenamente las características de los cassette de vídeo S-VHS.

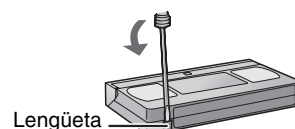

Reproducción de un cassette de vídeo

Operaciones preliminares

- Seleccione la unidad que ve el canal (o la entrada AV) en el televisor.
- Pulse [VHS].

1 Pulse [⏻**, DVD/VHS POWER] para encender la unidad.**

2 Inserte un cassette de vídeo grabado. (→arriba)

3 Pulse [▶**, PLAY].**

- La reproducción inicia automáticamente si inserta un cassette de vídeo al que se ha quitado su lengüeta.

■ **Para reproducir todavía**

Pulse [■, PAUSE]. (Pulse nuevamente la tecla para reanudar la reproducción.)

■ **Para detener la reproducción**

Pulse [■, STOP].

Nota:

- Cuando está apagada la unidad, un cassette de vídeo insertado puede ser reproducido pulsando [▶, PLAY].
- Cuando la cinta llega al fin, esta unidad la rebobina automáticamente hasta el comienzo. Esta función no obra durante la grabación temporizada, el avance rápido y la grabación con parada especificada.
- La búsqueda Jet, la localización progresiva, el rebobinado o la reproducción lenta se quitan automáticamente a los 10 minutos, y la reproducción de imagen fija a los 5 minutos.
- Cuando ve una imagen fija o una reproducción lenta, la imagen que aparece en el modo VP puede resultar distorsionada.
- Cuando reproduce una cinta que fue grabada en otro VCR, puede ser necesario ajustar la pista. En algunos casos, la calidad de la imagen podría resultar todavía inferior. Esto se debe al formato limitado.

Operaciones preliminares

- Pulse [VHS].

Avance rápido / Rebobinado

Mientras el disco está detenido

Pulse [**◀◀**] (atrás)/[**▶▶**] (en avance).

Localización progresiva / Rebobinado

Durante la reproducción

Dé un ligero golpe en o mantenga pulsado [**◀◀**] (atrás)/[**▶▶**] (en avance).

- Si mantiene pulsadas estas teclas, la reproducción vuelve a iniciar soltándolas.
- Pulse [▶, PLAY] para volver a iniciar la reproducción.

Búsqueda Jet

Durante la reproducción

Dé un ligero golpe en [**◀◀**] (atrás)/[**▶▶**] (en avance) dos veces. Puede aumentar la localización progresiva/velocidad de búsqueda en rebobinado.

- Pulse [▶, PLAY] para volver a iniciar la reproducción.
- Seleccione la velocidad de búsqueda para ver la imagen grabada.
- La imagen que aparece en el modo EP o VP a una velocidad aproximada de 35 veces puede resultar distorsionada. Puede ocurrir un desplazamiento vertical. Esto no es un funcionamiento defectuoso pero puede tener lugar, cambie a una velocidad aproximada de 27 veces.
- La imagen podría ser incolora o podría resultar distorsionada según el televisor.

Lento

Durante la reproducción

Pulse y mantenga [■, PAUSE] durante 2 segundos o más.

- Pulse [▶, PLAY] para volver a iniciar la reproducción.

Rebobinado Jet

Para lograr un rebobinado más rápido

Pulse [**JET REW** ◀◀].

La indicación "J. REW" aparece en la pantalla del televisor (salvo cuando aparece la indicación del tiempo que queda en la cinta).

- Según la cinta o la condición de funcionamiento, la velocidad de rebobinado puede variar un poco.
- El contador de la cinta se repone a "0:00.00" cuando la cinta se rebobina desde el comienzo.
- Según la cinta, esta función podría no obrar.

Cuasi reproducción S-VHS (SQPB)

Es también posible reproducir cintas grabadas en el sistema S-VHS.

- Pueden tener lugar algunos ruidos según el tipo de cinta utilizada.
 - No es posible conseguir plenamente una resolución más alta que la que es capaz el S-VHS.
- No es posible grabar en el sistema S-VHS con esta unidad.

Reproducción repetida

Durante la reproducción o mientras que está detenida Mantenga pulsado [▶, PLAY] durante 5 segundos o más.

- En el visualizador aparece la indicación "RP".
- Al terminar el programa, la cinta se rebobina hasta el comienzo y la reproduce nuevamente (esto sólo funciona si destella al menos 5 segundos al fin del programa). Esto se repite hasta que se suprime.

■ **Para borrar**

Pulse [■, STOP].



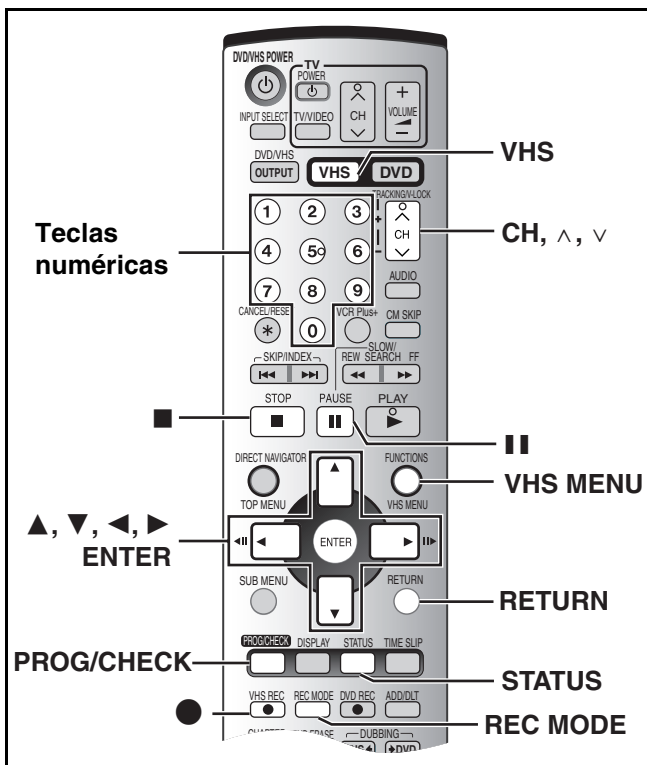

Grabación de programas televisivos

Operaciones preliminares

- Seleccione la unidad que ve el canal (o la entrada AV) en el televisor.
- Compruebe que el reloj esté ajustado al tiempo justo.
- Pulse [VHS].

1 Inserte un cassette de vídeo que tenga la lengüeta intacta de protección contra el borrado accidental. (→ 81)

2 Pulse [CH, ^, v] para seleccionar la estación TV.

- Es también posible seleccionar los canales con las teclas numéricas.

Modo TV (Ondas hertzianas)

por ej., "5": [0]→[5]

"15": [1]→[5]

Modo CATV (Cable)

por ej., "5": [0]→[0]→[5]

"15": [0]→[1]→[5]

"115": [1]→[1]→[5]

3 Pulse [RECMODE] para seleccionar la velocidad de la cinta.

Cada vez que pulsa la tecla:

SP→EP→VP→SP

4 Pulse [●, VHS REC] para iniciar la grabación.

■ Para detener temporalmente la grabación

Pulse [■, PAUSE]. (Pulse nuevamente la tecla para reanudar la grabación.)

■ Para detener la grabación

Pulse [■, STOP].

Velocidad de la cinta

SP: Puede grabar la longitud señalada en la cinta.

EP: Tres veces la longitud del modo SP.

VP: Cinco veces la longitud del modo SP.

- Para conseguir una duración de grabación más larga, seleccione "EP" o "VP".
- Si la calidad de la imagen es importante para Ud. o bien si quiere almacenar la cinta durante un largo período, seleccione "SP".
- Esta unidad puede reproducir cintas grabadas con el modo LP en otro equipo (se enciende "LP" en el visualizador).

Modo VP:

- "VP" destella en el visualizador de la unidad durante 8 segundos después de iniciar la grabación.
- Una cinta grabada en el modo VP por esta unidad no puede ser reproducida por otro modo VCR. Se recomienda que se la distingue de otra cinta indicando "VP" en su etiqueta, etc.
- Lleva más tiempo para que funcione la pista automática cuando se reproducen cintas en el modo VP y, en algunas cintas, podría no funcionar de ninguna manera.

Nota:

- Aunque el cassette que usa tenga la etiqueta "S-VHS", no es posible grabar en el sistema S-VHS con esta unidad. Ésta se graba en el normal sistema VHS.
- No puede reproducir grabaciones VP en otro equipo.
- No puede cambiar canales mientras graba. Puede cambiar canales mientras está en el modo de pausa.
- Cuando la grabación está en pausa durante más de 5 minutos, la unidad vuelve al modo de parada.

■ Para visualizar el tiempo aproximado que queda en la cinta

- 1 Pulse [VHS MENU].
- 2 Seleccione "SELECCIONAR CINTA" con [▲, ▼].
- 3 Utilice [◀, ▶] para seleccionar la correspondiente longitud de la cinta.
- 4 Pulse [STATUS].

El visualizador cambia tan pronto como se pulsa cada vez [STATUS].

Reloj→Contador→Tiempo que queda en la cinta→Reloj

- El tiempo que queda en la cinta podría no visualizarse correctamente según la cinta usada.

■ Para especificar un tiempo para detener la grabación Durante la grabación

Pulse [●, VHS REC] para seleccionar el tiempo de grabación.

- En la unidad principal, pulse [●, REC].

Visualización de la unidad

Cada vez que pulsa la tecla:

Contador (suprimir) → 0:30 → 1:00 → 1:30

↑ 4:00 ← 3:00 ← 2:00 ←

Referencia

- Esto no funciona durante las grabaciones temporizadas.
- Pulsando [■, STOP] la grabación se detiene y el horario configurado se borra.
- El tiempo ajustado se va a borrar si cambia Ud. el modo de grabación o bien el canal mientras que la grabación está en pausa.

Recepción de las transmisiones televisivas durante la grabación

●→ 79

■ Precauciones en la grabación temporizada

- Cuando llega el tiempo que se definió, la grabación temporizada inicia automáticamente.
- La grabación temporizada puede iniciar mientras la unidad está tanto apagada como encendida. Cuando la unidad está apagada, el sonido y el vídeo no salen en el televisor.

Puede introducir hasta 16 programas con un adelanto de un mes.

Operaciones preliminares

- Selección de la unidad que ve el canal (o la entrada AV) en el televisor.
- Compruebe que el reloj esté ajustado al tiempo justo.
- Inserte un cassette de vídeo que tenga la lengüeta de protección contra el borrado accidental intacta. (→ 81)
- Pulse [VHS].

Uso del sistema VCR Plus+

Se refiera a "Uso del sistema VCR Plus+", paso 1-5. (→ 80)

Programación manual

- Cuando se conecte una caja TV de cable o un receptor de satélite, seleccione el canal en la caja TV de cable o receptor de satélite antes de que comience la grabación temporizada.

1 Pulse [PROG/CHECK].

- Cerciórese de que esté seleccionado "NUEVO PROGRAMA".

2 Pulse [ENTER].

3 Utilice [▶] para desplazar y cambiar los detalles con [▲, ▼].

- Pueden usarse las teclas numéricas para introducir "CA", "FECHA", "ACT" y "DES".
- **CA** (Posición del programa/Nombre de la estación de TV)
- **FECHA**
Puede crear usted un programa diario o semanal.
- **ACT** (hora de encendido)/**DES** (hora final)
Si mantiene pulsado el botón, el tiempo aumentará o disminuirá en incrementos de 30 minutos.
- Velocidad de la cinta
Para cambiar el modo de grabación, puede pulsar también [REC MODE].
SP↔EP↔VP↔A*↔SP.. (→ 82)
* Modo SP/EP automático (→derecha)

4 Al terminar las correcciones pulse [ENTER].

- "⊖" se enciende en el visualizador de la unidad.
- Para continuar programando:
Seleccione "NUEVO PROGRAMA" y repita los pasos 2-4.

5 Pulse [RETURN].

Nota

- "⊖" y "⊞" destella cuando la unidad no puede alcanzar la grabación temporizada (por ejemplo, el cassette de vídeo sin lengüeta de protección o bien un cassette de vídeo en su respectivo compartimento).
- El tiempo real grabado podría alargarse más allá del programa mismo cuando los programas TV se graban usando el sistema VCR Plus+.
- Si ajusta "HL" (Tiempo de ahorro de la luz del día) a "ACT" cuando ajusta manualmente el reloj, la grabación temporizada podría no funcionar cuando del verano cambia al invierno y viceversa.

■ Para detener la grabación mientras un programa está trabajando

Pulse [■, STOP], luego [ENTER] dentro de 5 segundos.

- Puede también seguir pulsando [■] en la unidad principal durante más de 3 segundos para detener la grabación.

Modo SP/EP automático

Si, al comienzo del programa temporizado, no hay cinta bastante para terminarlo, la función SP/EP hará marchar automáticamente la cinta a la velocidad EP. Esto garantiza que será grabado el entero programa. Si el modo EP no es bastante para alargar la cinta que queda, no será posible grabar todo el programa TV.

Programación temporizada

Primer programa (30 min.)	Segundo programa (60 min.)	
Cinta de vídeo		
30 min. en SP	15 min. en SP	45 min. en EP

- No es posible activar automáticamente el modo VP.
- La longitud de la cinta ha de ser ajustada correctamente.
- Algunas cintas podrían no funcionar correctamente.
- Si cambia el modo de grabación de SP a EP durante la grabación temporizada, en aquel punto podría tener lugar una breve distorsión de la imagen.

Controle, cambie o borre el programa

Se refiera a "Controle, cambie o borre el programa", paso 1-5. (→ 80)

Precauciones al usar la grabación temporizada en DVD y VHS

- → 80

Manufactured under license from Dolby Laboratories.
“Dolby” and the double-D symbol are trademarks of Dolby Laboratories.

“DTS” and “DTS 2.0+Digital Out” are trademarks of Digital Theater Systems, Inc.

Apparatus Claims of U.S. Patent Nos. 4,631,603, 4,577,216, and 4,819,098, licensed for limited viewing uses only.

This product incorporates copyright protection technology that is protected by method claims of certain U.S. patents and other intellectual property rights owned by Macrovision Corporation and other rights owners. Use of this copyright protection technology must be authorized by Macrovision Corporation, and is intended for home and other limited viewing uses only unless otherwise authorized by Macrovision Corporation. Reverse engineering or disassembly is prohibited.

VCR Plus+ and PlusCode are registered trademarks of Gemstar Development Corporation.
The VCR Plus+ system is manufactured under license from Gemstar Development Corporation.

Pats. 5,307,173; 5,335,079; 4,908,713; 4,751,578; and 4,706,121

MPEG Layer-3 audio decoding technology licensed from Fraunhofer IIS and Thomson multimedia.

Panasonic Consumer Electronics Company, Division of Matsushita Electric Corporation of America
One Panasonic Way Secaucus,
New Jersey 07094
<http://www.panasonic.com>

Panasonic Sales Company, Division of Matsushita Electric of Puerto Rico, Inc. (“PSC”)
Ave. 65 de Infantería, Km. 9.5
San Gabriel Industrial Park, Carolina,
Puerto Rico 00985

Panasonic Canada Inc.
5770 Ambler Drive
Mississauga, Ontario
L4W 2T3
www.panasonic.ca